



Aastra Business Communication Solution



Aastra 5370/5370ip User's Guide

Supported platforms:

Aastra 415

Aastra 430

Aastra 470



This user's guide describes the functions, the configuration, and the use of the Aastra 5370/5370ip.

Operating and display elements

Operating elements

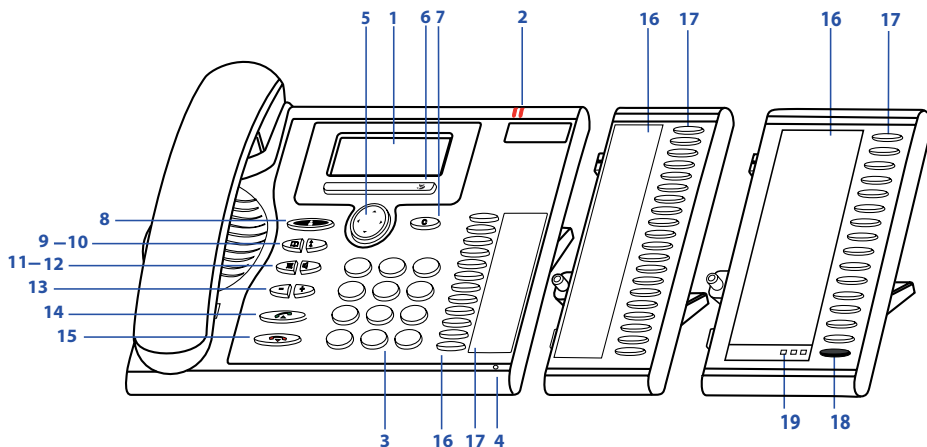

1 Display

- In the upper area: status display with symbols.
- In the middle area: current displays on the telephone traffic.
- In the lower area: display of the available Foxkey functions.

2 Indicator LED

- Left LED flashes: Call.
- Right LED is lit: Voice message, message, or callback.



3 Key block

Enters digits or letters.



4 Hands-free microphone

5 Navigation key

- Upward: Resetting *Activated features*.
- To the right: Opens the *Menu*.
- Downward: Opens *Settings*.
- General: Scrolls forwards/backwards in the menu, navigates lists.



6 Foxkey

Executes displayed function using the key. Foxkeys can be freely configured.



7 Correction key

Deletes the last character or goes back one step in the menu.



8	<p>Presence key with LED Preconfigured as presence menu. The Absence key can be configured as a function key or digit key.</p>	
9	<p>Phone book key Opens phone books.</p>	
10	<p>Redial key Selects the phone numbers last dialled.</p>	
11	<p>Microphone key Hands-free or handset microphone off / on.</p>	
12	<p>Loudspeaker key Hands-free operation on/off.</p>	
13	<p>Volume/cursor keys Adjusts volume.</p>	
14	<p>Call key Set up / answer a call.</p>	
15	<p>End key</p> <ul style="list-style-type: none"> • Ends a call. • Exits input without saving and goes back to the idle state. 	
16	<p>Configurable keys/Line keys with LED (incl. Aastra M530/Aastra M535 expansion key module) Freely configurable as number, function or Team key:</p> <ul style="list-style-type: none"> • Number key with two storage locations: Press once for first call number, presse twice for second call number (only Aastra M530). • Function key: Activate / deactivate function. • Team key: Call or pick up a call. Announcement to a team partner (press twice). <p>If preconfigured as a Line key: Set up or answer call via line. Configure key: press and hold down.</p>	
17	<p>Write-on labels (incl. Aastra M530 expansion key module) Write-on labels for the configurable keys can be found on the Aastra 400 DocFinder. You can fill out the fields directly on your PC and then print out the labels.</p>	
18	<p>Shift key on Aastra M535 expansion key module Switch between the 3 views. Press 1 x each to display the next level.</p>	
19	<p>LED display on Aastra M535 expansion key module Indicates which of the 3 levels is activated.</p>	

Display symbols

Status information			
	Detailed information available		Other Foxkeys available (Foxkey)
	Search mode		Function activated
	Entries in call list		New text messages
	Forwarding activated		Call Forwarding on No Reply activated
	New voice messages		<ul style="list-style-type: none"> Voice message retrieved Voice mail greeting with possibility to leave a voice message
	Voice mail greeting without possibility to leave a voice message		
	New, forwarded voice message ^[a]		Retrieved forwarded voice message ^[a]
	Hi-Q™ during a call (enhanced audio quality) (only Aastra 5370ip)		Data and voice encryption (only Aastra 5370ip)
	Call parked		Retrieve parked call (Foxkey)
	Activate discreet ringing		Melody deactivated
	Microphone deactivated		Loudspeaker/hands-free mode activated
	Headset mode activated		Telephone barred
	Call recording ^[a]		

Phone book



Business number



Private number



Mobile number

Presence state



Available (default)



Absent



Meeting



Busy



Not available

Display symbols Aastra M535

Expansion key module



Business number



Private number



Mobile number



Line key

Product information

Safety information

Failure to observe this information can be hazardous and infringe existing laws.



Connections

Always plug the phone cable connectors into the appropriate sockets. Do not modify the connections in any way.



Mains power

Use the original power supply only. Connect the power supply only to power sources that conform to the indications on the power supply. The device will be inoperable when mains power of the communications system fails.



Retention of Metal Objects

Telephone receivers produce magnetic fields that can attract small metallic objects such as pins and staples. To avoid injury, do not place the handset where such objects can be picked up.



Maintenance

Make sure all installation and repair work is carried out by a specially qualified technician.

Always use a soft, moistened, or antistatic cloth to clean your device. Do not use chemicals or other chemical products.



Cost control and Data protection

You should protect your phone with a PIN so that no-one can make phone calls at your expense. A code will also protect your personal settings.



Ambient conditions

Do not operate the device outside the temperature range of +5 °C to approx. +40 °C. Avoid direct sunlight and other sources of heat.

Protect your device against the wet, excessive dust, corrosive liquids and steam.

Do not expose your device to electromagnetic fields (electric motors, household appliances). The speech quality could be affected. To prevent interference, avoid placing your handset in the immediate vicinity of computers, radios, TV sets, VCRs, and other telephone sets.



Disposal

Be sure to dispose of your device, batteries and its packaging in an environmentally compatible way. Electrical equipment does not belong in domestic waste. Deposit it at a return centre.



Accessories

Use original accessories or specifically approved accessories only. The use of other accessories may decrease performance or pose a risk to your health or safety.

User information

DocFinder for the Aastra 400 communication platform: www.aastra.com/docfinder

© The information, graphics and layouts featured in the user information are subject to copyright and may not be duplicated, presented or processed without the written consent of Aastra Telecom Schweiz AG.

Your product is supplied with a Quick User's Guide, safety information and, where applicable, with other product-specific information.

These and all other user documents are available for download on the Aastra 400 DocFinder: www.aastra.com/docfinder as individual documents or as a documentation set. It is your responsibility to keep up to date with the scope of functions, the proper use and the operation of your product.

- Make sure you have all the user documents required to operate your product efficiently and correctly.
- Make sure that the versions of the user documents comply with the software level of the Aastra 400 products used and that you have the latest editions.
- Always read the user documents first before you put your product into operation.
- Store the user information within easy reach and refer to it whenever uncertainties arise in connection with the use of the product.
- When handing over your product to others, make sure you enclose the relevant user information.

Purpose and function

This product is part of the Aastra 400 communication solution.

Aastra 400 is an open, modular and comprehensive communication solution for the business sector with several communication servers of different output and expansion capacity, a comprehensive telephone portfolio and a multitude of expansions. They include an application server for Unified Communications and multimedia services, an FMC (Fixed Mobile Conversion) controller for integrating mobile phones, an open interface for application developers and a multitude of expansion cards and modules.

The business communication solution with all its components was developed to cover in full the communication requirements of businesses and organisations, in a way that is both easy to use and maintenance-friendly. The individual products and components are coordinated and must not be used for other purposes or replaced by third-party products or components (unless it is to connect other approved networks, applications and telephones to the interfaces certified specially for that purpose).

One number user concept:

Your system administrator can set up several phones for you that hold all the same phone number (one number user concept). You have only one name and phone number with which to identify yourself to your call partners, regardless of which of the phone you make your calls. The advantage is that you can always be reached under the same phone number, regardless of where you happen to be.

With Personal call routing you can define where incoming calls shall be routed to (see chapter "[Activating personal call routing](#)", page 62). You can determine the phone on which a call is acoustically signalled, with Ring Alone (see Chapter "[Activating ring alone](#)", page 62). Your system administrator can set whether or not you are busy for further incoming calls (Busy if busy). You are still able to make further outgoing calls with the other terminals.

Call lists and contacts are available on all your phones and are automatically synchronised.

An announcement is signalled on all your phones which support announcement.

Protection against listening in and recording

The Aastra 400 communication solution comprises features which allow calls to be monitored and recorded without the call parties noticing. Please note that these features can only be used in compliance with national data protection provisions.

Communication system and software versions

Some communication systems or software versions do not support all the features. The corresponding text sections are identified by a letter inside square brackets. The Chapter "[Communication system and software versions](#)", page 114 indicates which software versions support the relevant features.

Exclusion of liability

All parts and components of the Aastra 400 communication solution are manufactured in accordance with ISO 9001 quality guidelines.

The relevant user information has been compiled with the utmost care. The functions of the Aastra 400 products have been tested and approved after comprehensive conformity tests. Nonetheless, errors cannot be entirely excluded. The manufacturers shall not be liable for any direct or indirect damage that may be caused by incorrect handling, improper use, or any other faulty behaviour. Potential hazards are mentioned in the relevant places in the user information. Liability for loss of profit shall be excluded in any case.

Trademarks

Aastra® is a registered trademark of Aastra Technologies Limited.

Bluetooth® is a registered trademark of Bluetooth SIG, Inc. All other trademarks, product names and logos are trademarks or registered trademarks of their respective proprietors.

The designations used in this manual for software and hardware are registered trademarks and are thus subject to the relevant regulations.

Document information

- Document number: eud-1281
- Document version: 1.2
- Based on software version: R2.0
- Valid as of software version: R1.0
- Copyright © 02.2012 Aastra Technologies Limited
- In PDF Viewer, click on this link to download the latest version of this document:
https://pbxweb.aastra.com/doc_finder/DocFinder/eud-1281_en.pdf?get&DNR=eud-1281

Content

Operating and display elements	2
Product information	6
Dialling and phoning	13
Answering calls	14
Making calls	15
Using the display and operating elements	19
Display	20
Keys	21
Input	22
Menu-guided navigation	24
Signals	25
Supplementary features	26
Making and answering calls	27
Using functions while in a call	37
Organising absences from the desk	42
Functions for special situations	51
Setting functions by remote control	66
Organisation within the team	67
Line keys	69
Personalizing your phone	72
Display	73
Setting the ringing properties (Audio)	75
Hands-free and headset settings	77
General settings	79
Protection settings	83
Phone Book Management	84
Configuring voice mail	86
Configuring presence	87
Configuring keys	89
Configuring Line Keys	94
Formulating functions	96

Installation and first-time operation	98
Equipment provided	99
Options	100
Setting up and mounting the phone	101
Connect Aastra 5370	105
Connect Aastra 5370ip	106
Aastra M530/Aastra M535 expansion key module (optional)	108
Labelling the Aastra M530 expansion key module	110
Further information	111
Troubleshooting	112
Declaration Open Source Software (Aastra 5370ip)	113
Communication system and software versions	114
Index	115

Dialling and phoning

The following sections explain how to make phone calls simply and the functions your phone offers you whenever you receive a call.

<i>Answering calls</i>	14
<i>Making calls</i>	15

Answering calls

This section explains the procedure for answering a call.

Answering a call

Your phone is ringing and the indicator LED is flashing. To answer the call, proceed as follows.



Pick up the handset.

Note:

If the caller's phone number is received, it is shown on the display. If the phone number is stored in the private phone book or in the system, the display also shows the corresponding name.



Hands-free operation:

Press the Call key or Loudspeaker key.

Notes:

- To find out how to make phone calls with the headset, refer to the Chapter "Using a headset", page 18.
- To find out how to make phone calls in hands-free mode or in automatic hands-free mode, refer to the Chapter "Using your phone in hands-free mode", page 17 and the Chapter "Automatic hands-free mode", page 77 respectively.

Ending a call

You want to end the call.

After the call the call duration is indicated. Call charges are also displayed after any external call which you initiated, provided your provider supports this function.



Put the handset on-hook.



Ending a call in hands-free mode:

Press the End key or Loudspeaker key.

Notes:

- To find out how to make phone calls with the headset, refer to the Chapter "Using a headset", page 18.
- To find out how to make phone calls in hands-free mode or in automatic hands-free mode, refer to the Chapter "Using your phone in hands-free mode", page 17 and the Chapter "Automatic hands-free mode", page 77 respectively.

Making calls

This section explains the different ways you can make a call with your phone.

Dialling with the phone number

You want to call someone and key in that person's phone number.

With call preparation you can enter a phone number without it being dialled automatically, so you have time to check the number and, if necessary, correct it. The number is not dialled until you go off-hook, for example by picking up the handset.

For the communication system (communication server, OIP, Microsoft Outlook, Twix-Tel) to identify an external number it is recommended to enter the number in canonical format (+Country Code (Region Code) Phone Number). Press the **+** key to insert +. You can enter the phone number in one of the following formats:

- 0-004132655xxxx
- 004132655xxxx
- 9-004132655xxxx
- +41 (32) 655xxxx

<Phone number>



Enter a phone number in call preparation.

Press the **+** key to enter +.

You can use the Correction key to delete any incorrect character.



Pick up the handset.

Or:

Press the Call key or the Call Foxkey.

→The user is called.

Dialling with redial

You want to call a person you have already called.

In the last-number redial list your phone automatically stores the phone numbers of the persons you have already called, complete with their names, where available. You can now call the person in question using this last-number redial list.

The last-number redial list has a maximum of 10 entries.



Press the Redial key.
→ Redial list is displayed.



Press the Redial key several times or press the down navigation key to scroll through all the phone numbers you last dialled.



Pick up the handset.
→ The phone number displayed is dialled.

Using your phone in open listening mode

You want other people in the room to be able to listen in to the call.

The open listening function lets you activate the loudspeaker in addition to the handset.



During a call:
Press the Loudspeaker key.
→ Open listening is now activated,  is displayed.

Note:
You can continue with the call as usual using the handset.



Deactivating open listening:
Press the Loudspeaker key a second time.
→ Open listening is now deactivated.

Note:
To end a call in open listening mode, you need to press the Loudspeaker key and hang up the phone. If you merely replace the handset, the phone switches to the hands-free mode.

Using your phone in hands-free mode

You want other people to join the conversation or to have your hands free while making the call.

The hands-free mode function activates the loudspeaker and the microphone.



During a call:

Press the Loudspeaker key.

→ Open listening is now activated,  is displayed.



Put the handset on-hook.

→ The hands-free mode is now activated,  is displayed.

Notes:

- Make sure the hands-free microphone is not obstructed.
- The sound quality is improved if you set the volume of your phone to a low setting.



To continue the call with the handset:

Pick up the handset.

→ The loudspeaker and hands-free microphone are now deactivated.

Notes:

- To find out how to make phone calls with the headset, refer to the Chapter "Using a headset", page 18.
- To find out how to activate the automatic hands-free mode, refer to the Chapter "Automatic hands-free mode", page 77.

Muting the microphone

In the middle of a call you want to talk briefly with other persons in the room without your call partner hearing your conversation.

You can switch the microphone on and off during a call.



Switching the microphone off:

Press Microphone key.

→ The microphone is deactivated,  is displayed.



Switching the microphone back on:

Press the Microphone key once again.

Using a headset

To make a phone call with the headset.

If you answer a call in headset mode using the Call key or Loudspeaker key, the call is provided on the headset. Alternatively you can also answer the call by picking up the handset.



Your phone is ringing and the indicator LED is flashing. To answer the call, proceed as follows:

Press the Call key or Loudspeaker key.

→ The call is provided on your headset.

Open listening



Press the *Open listening* Foxkey.

→ The phone's loudspeaker is activated.

Hands-free operation



Press the *Hands-free* Foxkey.

→ The phone's microphone is switched on and the headset microphone is switched off.

Headset



Press the *Headset* Foxkey.

→ Back to the headset mode.



Ending a call:

Press the End key or Loudspeaker key.

Notes:

- To find out how to activate the headset, refer to the Chapter "To activate headset operation", page 78.
- To call a user, select the user's phone number and press the Call key or Loudspeaker key.
- For more information refer to your headset's operating instructions.

Using the display and operating elements

The following sections explain how to operate your phone quickly and simply.

<i>Display</i>	20
<i>Keys</i>	21
<i>Input</i>	22
<i>Menu-guided navigation</i>	24
<i>Signals</i>	25

Display

Display symbols and display text

New events such as a call in your absence, a new message or activated functions (e.g. Forwarding) are signalled on the display in the idle state by a symbol or a display text. You can then use the relevant Foxkey to call up the information.

>>



If more Foxkeys are available:

Press the >> Foxkey.



Retrieving detailed information:

Press the right navigation key.



Function activated:

The activated function or selected setting is indicated by a check mark.

Close



Deleting the display text:

Press the *Close* Foxkey.

→ The display returns to the idle state; the function remains activated.

Keys

Using the Foxkey

The Foxkey has variable functions. These functions are displayed above the key. Several contacts are stored under the broad Foxkey, which means you need to press the Foxkey precisely under the function you want.



Press the Foxkey on the place where the function you want appears on top of the display.

<long>



Keep the Foxkey held down for a moment (about 2 seconds).

Using the Aastra M535 expansion key module

The configurable keys of the expansion key module Aastra M535 can be operated as the other configurable keys. In addition, there are the following extensions:

- If you remove an Aastra M535 or if you modify the order of the connected expansion key modules, the keys configuration does not change.
- The *M535 display contrast* applies to all connected Aastra M535 expansion key modules.
- The Aastra M535 display's *Backlight* setting is taken from the phone.
- The Aastra M535 has 3 levels with 15 configurable keys each.



Shift key:

Allows to switch between the 3 levels. Press 1 x each to display the next level.



LED display:

Indicates which level is activated.

→ If, for example, you are on level 3 of the Aastra M535 expansion key module and an event occurs on level 1, the event is signalled by the red blinking LED in position 1.

Input

Digit keys

You can use the digit keys for entering digits and passwords and for Quickdial. The characters are assigned to the digit keys as follows. Press the relevant digit key repeatedly until the character you want is displayed.



-.?1!,:;/'"¿ì



A B C 2 Ä Æ Å Ç
a b c 2 ä æ å à ç



D E F 3 É
d e f 3 é è ê



G H I 4
g h i 4 ì



J K L 5
j k l 5



M N O 6 Ñ Ö Ø
m n o 6 ñ ö ø ò



P Q R S 7
p q r s 7 ß



T U V 8 Ü
t u v 8 ü ù



W X Y Z 9
w x y z 9



+ 0



@ * / () < = > % £ \$ € ¥ ¢ & §



<Space> #

Enters digits

The digit keys are used to enter the digits 0 to 9.

Enter the letters

You can also use the digit keys to enter letters and special characters. A number of letters and special characters are assigned to each key.

To enter letters using the digit keys, you need to be in text mode. The text mode is activated automatically if the phone is expecting a text input. You can switch back and forth between number mode and letter mode during your input.

abc-->123



Switching between number mode and letter mode during your input:

Press the *abc-->123* or *123-->abc* Foxkey.

Switching between upper and lower case

You want to switch between upper and lower case while making an input in text mode.

Upper-case input is automatically activated when the first letter is entered. The text mode then automatically switches to lower-case input. You can use the Foxkey to switch manually between upper-case and lower-case input.



Switching between upper case and lower case in text mode:

Press the *a>A* or *A>a* Foxkey.

Correcting your input

You notice you have entered a wrong digit or character. You can either delete the input one character at a time or cancel the entire input.



To delete the last character:

Press the Correction key.

Note:

With the navigation key you can go straight to the character you want to delete.



End input without saving:

Press the End key.

Moving the Cursor

You want to go to a certain character for an input or correction.

With the navigation key you can move the cursor to the left or right.



Move the cursor with the horizontal navigation key.

Menu-guided navigation

Accessing the menu

The phone is in standby mode:

Menu



Press the *Menu* Foxkey.

→ The first menu entry is displayed.



Use the vertical navigation key to scroll through the menu entries.

Select



Press the *Select* Foxkey.

→ Accessing the displayed menu.

Using the navigation key

You can retrieve a particular menu entry even more simply and efficiently using the navigation key. You can scroll vertically and horizontally through the different menu entries.



Horizontal navigation key:

Left: scrolls back through the menu.

Right: opens displayed menu, scrolls forward through the menu, retrieves detailed information.



Vertical navigation key:

Bottom: opens *Settings*, scrolls downwards in the list.

Top: opens *Activated features*, scrolls upwards in the list.

Undoing actions

To cancel operating steps, proceed as follows:



End input without saving:

Press the End key.



Back to the idle state in the menu:

Press the End key.

Other navigation possibilities



Scrolling back through the menu:

Press the Correction key.

Resetting activated features

You can deactivate again all the activated functions (e.g. Forwarding, Barring).

Menu



Press the navigation key up.

→ All the activated functions are now displayed.

Or:

Retrievable also via menu: *Menu* > *Activated features*.

Reset



Reset the function in question.

→ The function is now deactivated.

Signals

Indicator LED signals

Depending on the situation the indicator LEDs either flash or remain steadily lit.



Left LED flashes:

→ Phone is ringing.



Right LED is lit:

→ New voice message, message, or callback received.

Note:

For an explanation of the indicator LED on expansion module Aastra M535, see chapter "Using the Aastra M535 expansion key module", page 21.

Supplementary features

The following sections explain the supplementary features provided by your phone for more efficient use.

<i>Making and answering calls</i>	27
<i>Using functions while in a call</i>	37
<i>Organising absences from the desk</i>	42
<i>Functions for special situations</i>	51
<i>Setting functions by remote control</i>	66
<i>Organisation within the team</i>	67
<i>Line keys</i>	69

Making and answering calls

This section explains some convenient features provided by your phone for making a call.

Dialling by name (Quickdial)

You want to make a call by entering a name.

With Quickdial you only need to press the digit keys for each letter once, even though each key is assigned several letters. An efficient algorithm provides quick search results.

Requirement: The name and the corresponding call number are stored in one of the system's phone book or in an external phone directory connected to the system.

The surname and first name have to be separated by a space (# key), for example "no s" (6 6 # 7) for Noble Stephen. Ask your system administrator whether you should start with the surname or the first name.

Notes:

- To be able to search in an external phone book using Quickdial, you need to press the * key or 0-key before entering the first letter.
- The response time may vary greatly depending on the size and the number of phone books connected.



Quickdial:

Press each of the corresponding digit keys once for the first few letters of the name you are looking for.

→ For each letter, the display shows the corresponding digit, for example a "6" for the letter "n".



Press the phone book key.

→ The phone searches for matching users.



You may have to enter another letter before the name you want or a list of users is displayed.



Scroll through the list until the user you want is displayed. Select the phone number you want.

Note:

If the phone is unable to find a matching user, *List empty* will appear on the display.



Pick up the handset.

→ The phone number displayed is dialled.

Dialling from the phone book

You want to search a user in one of the connected phone books.

The surname and first name have to be separated by a space, for example "no s" for Noble Stephen. Ask your system administrator whether you should start with the surname or the first name.

To find out to create a new contact in your private phone book, refer to the Chapter "[Creating a new phone book entry](#)", page 84.



Press the phone book key.

Search entry



Scroll to *Search entry* and press the *Select* Foxkey.

If required, enter the first few letters of the name you are looking for (first name and surname separated by a space) until the user or a list is displayed.

Notes:

- Text mode is activated automatically.
- Use the # key to enter spaces.



Scroll through the list until the user you want is displayed. Select the phone number you want.



Pick up the handset.

→ The phone number displayed is dialled.

Notes:

- The search function is not affected by upper/lower case and special characters.
- When searching in external phone books you must always enter portions of the first and last name and possibly of the town name.

Dialling from external phone books

If you select *Advanced search*, you can search directly in the connected external phone books. This function is not available if no external phone book is connected.

The surname, first name and town each have to be separated by a space, for example "no s so" for Noble Stephen in Solothurn. Ask your system administrator whether you should start with the surname or the first name.



Press the phone book key.

Advanced search



Scroll to *Advanced search* and press the *Select* key.

Enter the first few letters of the name you want (first and last name separated by a space).

If required, enter the first few letters of the town's name (name and town name separated by a space) until the user or a list is displayed.

Notes:

- Text mode is activated automatically.
- Use the # key to enter spaces.



Scroll through the list until the user you want is displayed.



Pick up the handset.

→ The phone number displayed is dialled.

Notes:

- The search function is not affected by upper/lower case and special characters.
- When searching in external phone books you must always enter portions of the first and last name and possibly of the town name.

Dialling from the call list of unanswered calls

You want to call someone who has previously tried to reach you.

Your phone automatically stores the phone number of this user in a call list and the display shows *Missed calls*. You can now call the person back using this call list.

The call list of unanswered calls contains a maximum of 10 entries.

Show



Calling a user back:

Press the *Show* Foxkey.

→ The display shows a list of the last unanswered calls.



Scroll through the list until the user you want is displayed.



Pick up the handset.

→ The phone number displayed is dialled. Once the call has been successfully connected, the entry is deleted from the call list.

Close



Hiding the "Missed calls" display:

Press the *Close* Foxkey.

→ Hides the display. The entry remains stored in the list of the last unanswered calls,  is displayed.

Note:

The call list of unanswered calls can also be selected using the menu: *Menu > Call lists > Unanswered calls*.

Dialling from the call list of answered calls

You want to call back someone whose call you answered.

Your phone automatically stored the person's phone number on the list of answered calls. You can now call the person back using this call list.

The list of answered calls contains a maximum of 10 entries.

Menu



Press the *Menu* Foxkey.

Call lists



Scroll to *Call lists* and press the *Select* Foxkey.

Answered calls



Scroll to the *Answered calls* call list and press the *Ok* Foxkey.

→ The display shows the list of the last calls.



Scroll through the list until the user you want is displayed.



Pick up the handset.

→The phone number displayed is dialed.

Dialling with redial

You want to call a person you have already called.

In the last-number redial list your phone automatically stores the phone numbers of the persons you have already called, complete with their names, where available. You can now call the person in question using this last-number redial list.

The last-number redial list has a maximum of 10 entries.



Press the Redial key.

→Redial list is displayed.



Press the Redial key several times or press the down navigation key to scroll through all the phone numbers you last dialled.



Pick up the handset.

→The phone number displayed is dialed.

Note:

Redial list can also be selected using the menu: *Menu > Call lists > Redial list.*

Selecting with configurable Foxkey

You want to call someone whose phone number is stored under a Foxkey.

You can dial the person by pressing the corresponding position on the Foxkey.

To find out how to configure a Foxkey, refer to the chapter "[Configuring keys](#)", page 89.



Press the configured Foxkey.

→The key's allocated phone number is shown on the display.



Pick up the handset.

→The phone number displayed is dialed.

Dialling with a configurable key

You want to call someone whose phone number is stored under a configurable key.

You can dial the person by pressing the corresponding key.

To find out how to configure a configurable key, refer to the chapter "[Configuring keys](#)", page 89.

<once short>



Activate the key's first allocated phone number:

Press the key once.

→ The key's first allocated phone number is displayed.

<twice short>



Activate the key's second allocated phone number:

Press the key twice in quick succession.

→ The key's second allocated phone number is displayed.



Pick up the handset.

→ The phone number is dialled.

Requesting a callback

You want to talk to a certain person. The person is busy or does not answer. You can make callback requests to both internal and external users. Not all providers support this function.

If the called party is busy, you can activate an automatic callback. In this case, your phone will start ringing as soon as the party you are trying to reach goes on-hook. When you pick up the handset, the person you want to call is dialled directly.

If the called party does not answer, you can also request a callback. The user then obtains a message indicating your callback request on his display.

You called someone and hear the busy tone or the ring-back tone.

Callback



To activate a callback request:

Press the *Callback* Foxkey.

→ You hear the acknowledgement tone.



Put the handset on-hook.

→ The display shows *Call expected*.

Close



Back to the idle state:

Press the *Close* Foxkey.

→ Callback remains activated.

Note:

The callback is stored in *Menu > Activated features* as long as it was not answered or cancelled by the system.

Reset**Reset callback:**

Press the *Reset* Foxkey.
 → Callback is deactivated.

Note:

You can only have 1 callback activated at a time and only 1 callback can be expected from you. Your callback request will automatically be cancelled by the system after about half an hour.

To answer the callback request

Someone has asked you to call back. You can tell this from the lit attention LED in the idle state. The display shows *Callback requested*.

Call**To answer the callback request:**

Press the *Call* Foxkey.
 → The phone number is dialled.

Delete**Clear callback:**

Press the *Delete* Foxkey.
 → Callback is deleted.

Note:

The callback can be changed via *Menu > Activated features > Delete* or *Call* as long as it was not answered or cancelled by the system.

Call waiting on an internal user

You want to talk to an internal user. However, the person is busy.

As a result of your call waiting, the person hears a call waiting tone and your phone number or name appears on his display. The user has the possibility of answering, deflecting or rejecting your call.

Requirement: It is essential that the internal user has not barred the Call waiting function on his phone (for configuration see the Chapter "[Activating protection against call types](#)", page 83).

Ask your system administrator whether the Call waiting function is enabled on the system.

Call waiting**User is busy:**

Press the *Call waiting* Foxkey.
 → You hear the dialling tone.

Note:

If the person rejects your call request or if call waiting is not possible, the call is, depending on the system's configuration, disconnected (busy tone) or forwarded to a preconfigured destination.

Answering call waiting

You are in a call and hear the call waiting tone. Another user is urgently trying to reach you.

You can either answer, deflect or reject the call.

Answer



Answering the call:

Press the *Answer* Foxkey.

→ The first call party is put on hold. You are now connected with the party who initiated the call waiting.

Note:

For more detailed information on how to broker between callers or set up a conference, please refer to the Chapters "Brokering between an enquiry call party and your call partner", page 38 and "Making a conference call", page 38 respectively.

Deflect



Deflect call:

Press the *Deflect* Foxkey.

<Phone number>



Enter the user's phone number and confirm with the *Ok* Foxkey.

→ Call-waiting party is put through.

Note:

You can also search in the phone book, last-number redial list or call list for the phone number of the person you are looking for.

Reject



Rejecting the call:

Press the *Reject* Foxkey or the End key.

→ You remain connected with your original call partner. Depending on the system configuration the call-waiting party hears the busy tone or he is forwarded to a preconfigured destination.

End call



Ending a current call:

Press the *End call* Foxkey.

→ The first call is terminated. You are now connected with the party who initiated the call waiting.

Starting an announcement

You want to address internal users directly via their loudspeaker – where available –, without waiting for a reply (similar principle to that of an intercom system).

Requirement: It is essential that the internal user has not barred his phone against announcement (for configuration see the Chapter "[Activating protection against call types](#)", page 83).



Pick up the handset.

Announcement



Press the *Announcement* Foxkey.

<Destination>



Select destination (*User* or *Group*) and confirm with the *Ok* Foxkey.

<Phone number>



Enter the phone number and confirm with the *Ok* Foxkey.

→ User is made aware of the announcement. You can now talk.

Note:

You can also search in the phone book, last-number redial list or call list for the phone number of the person you are looking for.

Or

Press *Menu* > *Call features* > *Announcement* > *User/Group* to start the announcement.

Receiving an announcement

You are made aware of the announcement by an acoustic signal, the display shows *Announcement*. You will be addressed via your loudspeaker.

You can listen to the announcement or stop it.



To continue the announcement as a phone call:

Pick up the handset.

→ You are now connected to the person who initiated the announcement.

Note:

If the announcement was started to a group, all the other recipients of the announcement are excluded.



To stop the announcement:

Press the End key.

Private call with PIN

You want to make a private call on your phone or on a third-party phone.

With the aid of your PIN you can use any phone to make an external call with your own personal settings, even if that phone is locked for external calls. The called party's display shows your personal phone number and not the number of the phone from which you are making your call. Any call charges incurred will be charged to you.

The call number dialled is not stored in the last-number redial list.



1. Enter function code #46 followed by your internal call number.
2. Enter your PIN.
3. Enter the external call number directly, without the exchange access digit.



Pick up the handset.

→ The phone is now enabled. The external user is called.

Note:

The default PIN setting "0000" is not accepted. First change the PIN as described in chapter "Changing the PIN", page 80 or use function code *47 (see "User's Guide Function Codes" on the Aastra 400 DocFinder: www.aastra.com/docfinder). If you have forgotten your PIN, your system administrator can reset it to the default setting.

Using functions while in a call

This section explains the different options provided by your phone while you are in a call.

Enquiry call during a call

You want to call someone else briefly without losing your current call partner. Then you want to resume your conversation with your original call partner.

With the *Enquiry call* function you can call someone else in the middle of a call and put your original call partner on hold. You can make enquiry calls to both internal and external users.

Enquiry call



<Phone number>



You are making/taking a call:

Press the *Enquiry call* Foxkey.

Enter the phone number of the enquiry call party.

→ Enquiry call party is called; first call partner is on hold.

Note:

You can also search in the phone book, last-number redial list or call list for the phone number of the person you are looking for.

End call



To end the enquiry call:

Press Foxkey *End call* or the End key.

→ You are now back through to your original call partner.

Notes:

- If your enquiry call party hangs up and you also go on-hook by mistake, you will hear a continuous ringing signal for 10 seconds to draw your attention to the person still on hold. If you press the Call key during the continuous ringing, you will be reconnected with your first call partner.
- If the other user does not answer, you can cancel the enquiry call with the *End call* Foxkey and take back the first call.

Brokering between an enquiry call party and your call partner

You are talking with an enquiry call party and have your original call partner on hold. You want to be able to switch back and forth between the two.

In an enquiry call you can use the brokering function to switch back and forth between an enquiry call party and the party on hold. Brokering is possible with both internal and external users. You can also broker between conference parties as a group and an enquiry call party.

Brokering



Brokering:

Press the *Brokering* Foxkey.

→ Your call partner changes. The other call party is put on hold.

End call



To terminate the current connection:

Press the *End call* Foxkey.

→ Call party disconnected. Connected with the call party on hold.

Making a conference call

You are in a call and have a call party on hold at the same time. You want to include the party on hold in the conversation and hold a conference call.

With the conference function you can include a call party on hold in the current conversation. From the conference call you can initiate an enquiry call to someone else. You can broker between the parties of the conference and the enquiry call party.

Depending on the system, a conference call can consist of up to 6 conference participants. You can hold a conference call with internal and external users.

Conference



To connect the call party on hold:

Press the *Conference* Foxkey.

→ The call party on hold is now included in the call.

Note:

Depending on the system configuration you may hear an attention tone.



Leaving a conference call:

Put the handset on-hook.

→ The other conference parties remain in the call.

Transferring a call partner

You want to put your call partner through to someone else.

With the *Enquiry call* function you can connect your call partner with someone else. You can connect internal and external users with one another.

Enquiry call



<Phone number>



You are making/taking a call

Press the *Enquiry call* Foxkey.

Enter the phone number of the enquiry call party.

→ Enquiry call party is called; first call partner is on hold.

Note:

You can also search in the phone book, last-number redial list or call list for the phone number of the person you are looking for.

Connecting with notification:

Wait until the person has answered the call. Announce the call party.

Put the handset on-hook or press the *Connect* Foxkey.

→ Your first call partner and the other person are now connected with each other.

Connect



Note:

If the other user does not answer, you can cancel the enquiry call with the *End call* Foxkey and take back the first call.

Connecting without notification:

Wait for the first ringing tone, then hang up.

→ The other party is then called directly by your first call partner.



Note:

Recall: If the other party does not answer, the call comes back to your phone.

Parking a call partner

You want to put your call partner on hold without using a phone line as a result.

You can park your call partner locally and take back at each phone assigned to you.

You can also allocate the Park function to a freely configurable key (see Chapter "Configuring keys", page 89).

Park



Press the **Park** Foxkey.

→ Your call partner is now parked locally; **[P]** is displayed.



Put the handset on-hook.

[P]



To retrieve a parked call party:

Press the *[P]* Foxkey.

→ Connected in hands-free mode.



To phone with the handset:

Pick up the handset.

Notes:

- With the End key the display returns to the idle state. As long as your call partner does not hang up, he remains parked. You can retrieve your parked call party using *Menu > Activated features > [P]*.
- The function code for central parking can be found in the "User's Guide Function Codes" on the Aastra 400 DocFinder: www.aastra.com/docfinder.

Recording a call

You want to record an active call with your call partner.

You can record an active conversation if you have been authorized to do so by your system administrator^[a]. Your call party can be an internal or an external user. The recordings are made and backed up only as .wave files in your individual e-mail boxes. For this, you must configure at least one e-mail address in the communication system. Contact your system administrator for more information.

You can start recording calls in the following situations:

- during an active call;
- During a conference call (with maximum two participants)
- During an incoming/outgoing call
- in prefix dialling;
- During dialling with a busy line.

Call recording only starts when the connection is set up. Therefore, no ring-back tones or wait tones are recorded.

Call recording is temporarily interrupted during an enquiry and an e-mail is sent with the recording made up till then. Recording restarts automatically once the call connection with the enquiry call party is set up and/or once the call connection with the first correspondent is restored.

The maximum recording time for each .wave file depends on the system configuration. When the preset or maximum recording time is reached, the recording stops automatically, the file is sent to your e-mail address and a new recording starts at the same time. Contact your system administrator for more information.

Notes:

- Recording calls may infringe on your national data protection provisions or be permitted only under certain circumstances. If you intend to use this function notify your call party in advance.
- You cannot record a conversation involving more than two call parties (enquiry call, conference). The recording is automatically stopped if you park your call party or put him on hold.

You can start or end call recording with the Foxkey or with a configurable key.

Record/Stop



Recording a call:

Record Foxkey or function key for <Call recording>, as soon as you have an incoming/outgoing call or an active call.

→ Call is recorded  is displayed on screen.

End the recording with the Stop Foxkey.

→ The recording is sent to your e-mail address.

Note:

The LED on the function key remains lit while the recording is in progress. The LED starts to flash before the recording reaches its maximum preset duration. Once the maximum duration is reached (or the memory is full), the recording is stopped and the LED goes off.

Call recording overview:

You can find the call recording overview in your e-mail box.

Organising absences from the desk

This section explains the different options provided by your phone when you want to leave your desk.

The Presence function lets you set your personal presence status quickly. It also tells you directly whether the user you want is reachable or absent without you having to call him. The information details depend on the type of telephone.











Organizing absences using the presence key

Your phone is equipped with a presence key, under which you can store presence profiles. By simply pressing the presence key you can activate a call forwarding unconditional.

Note:

You can configure the presence key like any other configurable key (see chapter "Configuring keys", page 89).

You have a choice of 5 presence profiles for controlling your presence status:

Presence status (presence symbol and presence LED)					
	<i>Available (default)</i>			<i>Not available</i>	
	<i>Absent</i>			<i>Meeting</i>	
	<i>Busy</i>				

You can call up the presence of the user you want in the following situations.

- when you call an internal user;
- in the phone book or in a call list;
- during dialling by name;
- via a Team key (only the busy status is indicated; on the Aastra M535 the corresponding presence symbol is indicated too).

Note:

External applications such as Open Interfaces Platform (OIP) can affect your presence status. Contact your system administrator for more information.

<Presence profile>

**To activate the presence profile:**

Press the function key for <Presence profile>.

Or:

The presence profile can also be selected using the menu: *Menu* > *Settings* > *General* > *Presence*.

Or:

Select the profile you want via the presence menu and press the *Ok* Foxkey.
→ The profile is activated.

<Presence profile>

**To deactivate the presence profile:**

Press the function key for <Presence profile>.

Or:

Select a new profile via the presence menu and press the *Ok* Foxkey.
→ The profile is deactivated.

<Setting value>

**To check a user's presence:**

Enter a complete internal name and press the presence key.

Or:

Select the user you want from the phone book or a call list.

Or:

Press the presence key, then a Team key.

→ Presence status is displayed.

Press the *Call* Foxkey.

→ The phone number is dialled.

Press the *Close* Foxkey.

→ User is not called, no entry in the call list.

Forwarding calls (Call forwarding)

You want to leave your desk. Calls for you are to be forwarded to a different destination (e.g. phone, voice mail, pager).

With call forwarding you can forward incoming calls directly to a different destination.

Notes:

- One diversion applies to all connected phones, in one number user concept.
- Only one forwarding variant at a time is possible.

Menu



Press the *Menu* Foxkey.

Forwarding



Scroll to *Forwarding* and press the *Select* Foxkey.

Call Forwarding Unconditional



Scroll to *Call Forwarding* and confirm with the *Ok* Foxkey.

User



Scroll to *User* and confirm with the *Ok* Foxkey.
Enter the user's phone number and confirm with the *Ok* Foxkey.
→ Forwarding is activated.

Notes:

- You can also search in the phone book, last-number redial list or call list for the phone number of the person you are looking for.
- If a call is to be forwarded only when you are already in a call, select *Forwarding if busy*.
- You can also forward to your *Voice Mail* (see Chapter "Forwarding to voice mail", page 46) or to a *Message* (see Chapter "Forwarding to a message", page 47).
- You can deactivate forwarding using *Menu > Activated features > Reset*.
- You can also activate forwarding by remote control, see Chapter "Setting functions by remote control", page 66.

Forwarding a Call on No Reply (CFNR)

You want calls that you receive on your phone to be forwarded to another destination.

Both your own phone and the other destination will then start ringing. The system configuration determines whether or not there is a ringing delay at the other destination. Whoever goes off-hook first, answers the call. Depending on the system configuration, Call Forwarding on No Reply can also be activated when your phone is busy.

Notes:

- Call forwarding applies to all connected phones, in the one number user concept.
- Only one forwarding variant at a time is possible.

Menu



Press the *Menu* Foxkey.

Forwarding



Scroll to *Forwarding* and press the *Select* Foxkey.

Call Forwarding on No Reply



Scroll to *Call Forwarding on No Reply* and confirm with the *Ok* Foxkey.

User



Scroll to *User* and confirm with the *Ok* Foxkey.

Enter the phone number of the destination to which your calls are to be forwarded and confirm with the *Ok* Foxkey.

→ Call forwarding is enabled.

Notes:

- You can also search in the phone book, last-number redial list or call list for the phone number of the person you are looking for.
- You can also forward calls to your *Voice Mail* (see Chapter "Forwarding to voice mail", page 46).
- You can deactivate forwarding on no reply using *Menu > Activated features > Reset*.
- You can also activate call forwarding by remote control, see chapter "Setting functions by remote control", page 66.

Forwarding to voice mail

You cannot momentarily be reached on your phone. If you forward to your voice mail, a user can leave you a voice message.

You can use the global greeting or your own greeting (see Chapter "Configuring voice mail", page 86).

For further information on voice mail refer to the "User's Guide Voice Mail Systems" on the Aastra 400 DocFinder: www.aastra.com/docfinder.

Notes:

- One diversion applies to all connected phones, in one number user concept.
- Only one forwarding variant at a time is possible.

Menu



Press the *Menu* Foxkey.

Forwarding



Scroll to *Forwarding* and press the *Select* Foxkey.

Call Forwarding Unconditional



Scroll to *Call Forwarding* and confirm with the *Ok* Foxkey.

Voice mail



Scroll to *Voice Mail* and confirm with the *Ok* Foxkey.

→ Forwarding is activated.

Notes:

- You can specify whether your voice mail should answer directly (*Call forwarding*) or with a delay (*Forwarding on No Reply*), or only if you are already on the phone (*Forwarding if busy*).
- You can deactivate forwarding using *Menu > Activated features > Reset*.
- A new voice message is signalled with a text message on the display and a lit indicator LED in the idle state.

Forwarding to a message

You cannot be reached on your phone. You want any internal user who calls you to get a text message. The user hears the busy tone and obtains a text message on his display.

Requirement: The internal user must have a phone capable of receiving text messages. Users whose phone cannot receive text messages are put through to your phone or rerouted to a destination predefined within the system.

You can use one of the text messages stored in the system directly, modify it or create a new message.

Notes:

- One diversion applies to all connected phones, in one number user concept.
- Only one forwarding variant at a time is possible.

Menu



Press the *Menu* Foxkey.

Forwarding



Scroll to *Forwarding* and press the *Select* Foxkey.

Call Forwarding Unconditional



Scroll to *Call Forwarding* and confirm with the *Ok* Foxkey.

Message



Scroll to *Message* and confirm with the *Ok* Foxkey.

<Message>



Select one of the text messages stored in the system and press the *Select* Foxkey.

Adapt or expand the text and confirm with the *Ok* Foxkey.

→ Forwarding is activated.

Note:

If you activate another forwarding, the message you have left on your phone will be deactivated.

Absence information

You wish to give your caller detailed information about your absence.

If you have configured call forwarding to voicemail in your presence profile, you can choose whether the currently active greeting, the global greeting, one of your personal greetings or an absence information should be played back to the caller^[a].

So-called absence information is available for each presence profile (*Absent, Meeting, Busy, Not available*).

Absence information consists of a language-dependent, predefined audio text. Optionally, the date and time are also given. Thereafter, the caller has the possibility to leave a message, if this is configured for the global greeting.

Example: "The person you have called is not available until 31st January, at 14:00. Please leave a message after the tone".

Available configuration possibilities:

- *Description*: Type in the text you want to be visible to other users as detailed information on your presence status (e.g. "At a meeting until 16:00").
- *Date/time*: choose whether the absence information should be given *without date/time* or with *date/time*.
- *Personal call routing*: Specify the phones on which a call is to be signalled (see chapter "Activating personal call routing", page 62).
 - *Keep settings as is*: Calls are routed according to your settings.
 - *Call routing-ID <1...5>*: your personal call routing number.
- *Call forwarding*: Specify where you want a call to be forwarded to (see Chapter "Forwarding calls (Call forwarding)", page 44).
 - *Keep settings as is*: Calls are routed according to your settings.
 - *No forwarding*: any configured call forwarding operation is deleted.
 - *User*: a call is channelled to the defined forwarding destination.
 - *Voicemail*: a call is forwarded to voicemail. The greeting to be played back can be configured with Voice mail greeting.
- *Voice Mail greeting*
 - *Keep settings as is*: your currently defined greeting is used.
 - *Absence information*: your caller is given an absence information (as well as date and time, if this has been configured as such in the presence profile).
 - *Standard greeting*: the global greeting is played back to your caller.
 - *Personal greeting* (if your personal greeting has been renamed, this name is displayed in the options): one of the personal greetings is played back to your caller.

Note:

The date and time are never given in the global greeting and personal greetings.

<Presence profile>



Press the function key for <Presence profile>.

Or: The presence profile can also be selected using the menu: *Menu* > *Settings* > *Presence*.

Modify



Select the profile you want and press the *Modify* Foxkey.

Voice Mail greeting



Scroll to *Voice Mail greeting* and press the *Modify* Foxkey.

<Setting value>



Select the required setting and confirm with the *Ok* Foxkey.

→ The setting is stored. Your caller hears the selected absence information, followed, if applicable, by date and time.

Locking your phone

You need to leave your desk and want to ensure that no-one can alter your phone's settings, look at your private data, or make outside calls from your phone.

You can lock your phone with a PIN consisting of two to ten digits. You can change it via menu (see the chapter "[Changing the PIN](#)", page 80) or with the function code *47 (see "User's Guide Function Codes" on the Astra 400

DocFinder: www.astra.com/docfinder).

Menu



Press the *Menu* Foxkey.

Settings



Scroll to *Settings* and press the *Select* Foxkey.

General



Scroll to *General* and press the *Select* Foxkey.

Lock



Scroll to *Barring* and press the *Modify* Foxkey.

→ You are prompted to enter your PIN.

<PIN>



Enter the PIN and confirm with the *Ok* Foxkey.

<Setting value>



Select the required type of barring and confirm with the *Ok* Foxkey.

→ The phone is now locked;  is displayed.

→ To lock all your phones, execute the function code *33* <PIN> # (see "User's Guide Function Codes" on the Aastra 400

DocFinder: www.aastra.com/docfinder).

Note:

You can lock either just the settings menu (*Lock settings*) or the entire phone (*Lock phone*). With *Lock phone* your private data cannot be viewed and external calls can only be made from your phone in accordance with the system settings.

Unlocking your phone

You want to unlock your phone.

You can use the PIN to unlock your phone. If you have forgotten your PIN, your system administrator can reset it to the default setting.

Menu



Press the *Menu* Foxkey.

Activated features



Scroll to *Activated features* and press the *Select* Foxkey.

<Barring>



Select the barring you want and press the *Reset* Foxkey.

→ You are prompted to enter your PIN.

<PIN>



Enter the PIN and confirm with the *Ok* Foxkey.

Unlocked



Scroll to *Free* and confirm with the *Ok* Foxkey.

→ The phone is unlocked.

→ To unlock all your phones, execute function code #33* <PIN> # (see "User's Guide Function Codes" on the Aastra 400

DocFinder: www.aastra.com/docfinder).

Functions for special situations

This section explains the different options provided by your phone to deal with special situations.

Function selection for configurable key

This section contains a list of all the functions you can store under a configurable key via the menu. Contact your system administrator for more information.

More information on how to store functions under a configurable key using function commands and function code can be found in chapter "Formulating functions", page 96.

Function	Description
<i>No function</i>	Select this function to delete the function key assignment.
<i>Call Forwarding Unconditional</i>	With this function you forward incoming calls directly to a different destination. For further information refer to Chapter "Forwarding calls (Call forwarding)", page 44.
<i>Forwarding if busy</i>	With this function you forward incoming calls directly to a different destination if you are busy. For further information refer to Chapter "Forwarding calls (Call forwarding)", page 44.
<i>Call Forwarding on No Reply</i>	With this function you forward incoming calls you receive on your phone to another destination. For further information refer to Chapter "Forwarding a Call on No Reply (CFNR)", page 45.
<i>Switch group</i>	This function lets you route calls and functions via switch groups (with two switch positions).
<i>Control output</i>	You can control external electric equipment or installations using control outputs. For example you can use your phone to open and close electric gates or to switch the lights on or off throughout a building.
<i>Welcome announcement</i>	Announcement service for incoming internal and external calls. If you do not answer an external call after a set delay, the user who is calling will obtain an announcement. After the announcement the caller will then hear the ring-back tone again.
<i>Lock</i>	This function protects you against Call Waiting and Announcement. For further information refer to Chapter "Activating protection against call types", page 83.
<i>Remote control</i>	This function lets you set remote maintenance access to your phone on a one-off basis or permanently.
<i>MCID</i>	This function lets you track a malicious call. For further information refer to Chapter "Tracking a malicious call", page 61.

Function	Description
<i>ACD (Automatic Call Distribution)</i>	The call routing of calls in the queue can be controlled using an ACD application.
<i>User group</i>	In the user group incoming and internal calls are routed to a group of internal destinations according to a preconfigured call distribution.
<i>Home alone</i>	If calls to a user group can only be answered by one user, the user in question can activate Home Alone on the user group. Then if the user is already in a call, all subsequent internal or external calls to the user group obtain a busy tone.
<i>configurable</i>	You can use function commands to define a function to suit your personal requirements. A function can consist of one or more function commands, function codes, and the phone number. You can either carry out a function directly or store it under a key. For further information refer to Chapter " Formulating functions ", page 96.
<i>CLIR</i>	This function lets you prevent your call number from being displayed to the caller. For further information refer to Chapter " Suppressing your call number from your called party's terminal display ", page 61.
<i>Deflect</i>	This function lets you deflect an incoming call to another user. For further information refer to Chapter " Deflect a call during the ringing phase ", page 53.
<i>Headset</i>	This function lets you activate the headset mode. For further information refer to Chapter " Using a headset ", page 18.
<i>Park</i>	With this function you put your call partner on hold without using a phone line as a result. For further information refer to Chapter " Parking a call partner ", page 40.
<i>Do not disturb</i>	With this function incoming calls are automatically forwarded to a specific destination. For further information refer to Chapter " Activating protection against call types ", page 83.
<i>Hands-free operation</i>	This function activates the loudspeaker and the microphone. For further information refer to Chapter " Using your phone in hands-free mode ", page 17.
<i>Discreet ringing</i>	With this function the phone rings only once. For further information refer to Chapter " Activating/deactivating a discreet ring ", page 60.
<i>Activate greeting</i>	This function allows you to activate/deactivate the greeting you want. For further information refer to Chapter " Managing personal greeting ", page 86.
<i>Ring alone</i>	This function lets you specify which of your phones signals incoming calls acoustically (as part of the one-number user concept). For further information refer to Chapter " Activating ring alone ", page 62.
<i>Personal call routing</i>	This function lets you specify where incoming calls are routed to (as part of the one-number user concept). For further information refer to Chapter " Activating personal call routing ", page 62.

Function	Description
<i>Personal call routing menu</i>	Menu for selecting the personal call routing. For further information refer to Chapter "Activating personal call routing", page 62.
<i>Ring off</i>	With this function the phone rings only once. For further information refer to Chapter "Setting the ringing properties", page 76.
<i>Fast take (Pick up a Call)</i>	You can take an incoming call or an active call from another phone to your phone. <i>Fast Take</i> must be enabled. Contact your system administrator for more information.
<i>Presence menu</i>	Menu for selecting a presence profile. For further information refer to Chapter "Organizing absences using the presence key", page 42.
<i>Presence</i>	Menu for selecting a presence profile. For further information refer to Chapter "Organizing absences using the presence key", page 42.
<i>Call recording</i>	This function allows you to record an active call. The recordings are stored in your individual e-mailbox only. For further information refer to Chapter "Recording a call", page 40.

Deflect a call during the ringing phase

You do not want to answer a call yourself but deflect it to another user.

With the function *Deflect* you can deflect calls to an internal or external user or to the voice mail during the ringing phase.

Your phone is ringing and the indicator LED is flashing. To deflect the call, proceed as follows.

Deflect



Press the *Deflect* Foxkey.

<Phone number>



Enter the phone number and confirm with the *Ok* Foxkey.

→ The call is deflected to the user you want.

Notes:

- You can also search in the phone book, last-number redial list or call list for the phone number of the person you are looking for.
- If the user you want to deflect to is busy, the call will not be deflected. The display shows *Busy* and your phone still rings.

Reject a call during the ringing phase

You do not want to answer a call.

You can reject a call already during the ringing phase.

Reject



Press the *Reject* Foxkey or the End key.

→ The connection is rejected and, depending on the system configuration, the caller obtains the busy tone or he is forwarded to a preconfigured destination.

Listening to voice message

Voice Mail from is displayed and the indicator LED is red-flashing.

Note:

Depending on the system configuration your system administrator can specify that you are notified by e-mail whenever you receive a new voice message (with the voice message attached). Contact your system administrator for more information.

Listen



Listening new messages:

Press the *Listen* Foxkey.

→ Message is played back.

Or:

Voice message can also be selected using the menu: *Menu* > *Call lists* > *Unanswered calls* > *Listen*.

Menu



To delete the message:

Press the *Menu* Foxkey.

Voice mail



Scroll to *Voice Mail* and press the *Select* Foxkey.

Inbox



Scroll to *Inbox* and press the *Select* Foxkey.

Delete



Press the *Delete* Foxkey.

→ The voice message is now deleted.

Notes:

- To find out how to configure call forwarding to your voice mail, refer to the Chapter "Forwarding to voice mail", page 46.
- To find out how to configure a voice mail, refer to the chapter "Configuring voice mail", page 86 or in the "User's Guide Voice Mail Systems" on the Aastra 400 DocFinder: www.aastra.com/docfinder.

Deflecting voice messages

Have you received a voice message which interests other users?

You can transfer incoming voice messages to other users^[a]. You can decide whether to keep a copy of each voice message.

Menu



Press the *Menu* Foxkey.

Voice mail



Scroll to *Voice Mail* and press the *Select* Foxkey.

Inbox



Scroll to *Inbox* and press the *Select* Foxkey.

Deflect



Select the voice message you want and press *Deflect*.

<Phone number>



Enter the call number and press the *Ok* Foxkey.

If you wish to keep a copy of the voice message, answer the questions with the *Yes* Foxkey.

→ The voice message is sent.

Send text messages

You want to send a written message to an internal user.

You can send a text message to an internal user. The text message will appear on the person's display.

Requirement: The internal user must have a phone capable of receiving text messages.

You can use one of the text messages stored in the system directly, modify it or create a new text message.

Menu



Press the *Menu* Foxkey.

Text message



Scroll to *Text message* and press the *Select* Foxkey.

New



Scroll to *New* and press the *Select* Foxkey.

<Text message>



Select one of the text messages stored in the system and press the *Select* Foxkey.

<Text>



Adapt or expand the text and press the *Send* Foxkey.

<Destination>



Select the destination and press the *Select* Foxkey.

<Phone number>



For *User* and *Group*: Enter the call number and press the *Send* Foxkey.
→The text message is sent.

Note:

If the display shows *Not available*, the text message could not be sent.

Read Text Messages

Your display shows *New message* and the envelope symbol. The right-hand indicator LED is lit.

Show



Show text message:

Press the *Show* Foxkey.

→ The display shows the sender and the date/time of the text message.

Read



Read text messages:

Select the text message you want and press the *Read* Foxkey.

→ If the text message runs over several lines, use the navigation key to scroll.

Delete



Delete text message:

Press the *Delete* Foxkey.

→ The text message is deleted; the next text message is retrieved from the memory.

Or:

Press *Menu* > *Text message* > *Inbox* to select the text message and continue as described above.

Note:

You can select and read a new text message even during an active call using *Text message* > *Inbox*.

Picking up a call

You hear a phone ringing in your vicinity and want to pick up the call.

With the *Pick up* function you can pick up the call from the other phone on your own phone.

Menu



Press the *Menu* Foxkey.

Call features



Scroll to *Call features* and press the *Select* Foxkey.

Pick up



Scroll to *Pick up* and confirm with the *Ok* Foxkey.

User



Scroll to *User* and confirm with the *Ok* Foxkey.

→ The display shows the number of the phone from which you last picked up a call.

<Phone number>



Enter the number of the phone from which you want to pick up the call and confirm with the *Ok* Foxkey.

→ You are now through to the caller.

Activating/deactivating DTMF mode

You want to be able to use your phone to control other equipment or to access certain services, such as remote polling of an answering machine or telebanking. For these services you need the DTMF mode.

In the DTMF mode each keystroke generates a tone. If for example you enter a call number during a call, your call partner will hear the tone signals.

You can specify whether the DTMF mode should be generally activated or deactivated (see Chapter "[Configuring the DTMF mode](#)", page 79). DTMF is activated as the default dialling mode.

If the DTMF mode is generally deactivated, you can activate it and deactivate it again temporarily during a call.

DTMF



You're in a call and the DTMF mode is generally deactivated. You want to activate the DTMF mode temporarily:

Press the *DTMF* Foxkey.

→ The display shows *Enter number DTMF*. You can now enter the DTMF characters.

Reset



Resetting DTMF mode:

Press the *Reset* Foxkey.

Note:

When you hang up, the DTMF mode is automatically deactivated again.

Making a call on a third-party phone

You want to make a call on a third-party phone using your personal settings, for example on a colleague's phone or in a meeting room.

You can activate a third-party phone to make an internal or external call using your personal settings, even if the phone is locked for external calls.

You can activate the phone for a business or private call.

Once you have activated the phone using a function code and your PIN, dialling by your private phone book is available.

The called party's display shows your personal phone number and not the number of the phone from which you are making your call.

Any call charges incurred will be charged to you.



1. Enter function code #36 for a business call.
2. Enter your internal phone number.
3. Enter your PIN.
4. Enter the internal or external phone number with the exchange access digit.

Pick up the handset.

→The phone number displayed is dialed.

Note:

When you hang up, dialling by name and your private phone book remain available for a whole minute so you can make another call.

Or:

1. Enter function code #46 for a private call.
2. Enter your internal phone number.
3. Enter your PIN.
4. Enter the external call number directly, without the exchange access digit.
5. Pick up the handset.

→The phone is now enabled; the external user is called.

Note:

The default PIN setting "0000" is not accepted. First change the PIN as described in chapter "Changing the PIN", page 80 or use function code *47 (see "User's Guide Function Codes" on the Aastra 400 DocFinder: www.aastra.com/docfinder). If you have forgotten your PIN, your system administrator can reset it to the default setting.

Paging an internal user using the general bell

You are unable to reach an internal user and thus want to page them.

When general bell is configured in the system, you can search for an internal user using the general bell. The paged person can answer from any phone.

Menu



Press the *Menu* Foxkey.

Call features



Scroll to *Call features* and press the *Select* Foxkey.

Page



Scroll to *Page* and confirm with the *Ok* Foxkey.

<Phone number>



Enter the phone number of the person to be paged and confirm with the *Ok* Foxkey.

→User is called and receives your phone number.

Answering a general bell

Via the general bell, you hear either your personal ringing pattern or the general ringing signal. Calls with the general bell as the destination can be signalled visually or acoustically via an external piece of supplementary equipment. The call can be answered on any phone.

Ask your system administrator whether a general bell is set up.

You can answer from any internal phone.

Menu



Press the *Menu* Foxkey.

Call features



Scroll to *Call features* and press the *Select* Foxkey.

Pick up



Scroll to *Pick up* and confirm with the *Ok* Foxkey.

General bell



Scroll to *General bell* and confirm with the *Ok* Foxkey.

<Phone number>



Enter your own phone number and confirm with the *Ok* Foxkey.
→ You are now connected with the person who is trying to reach you.

Note:

You can also answer a general bell using the function code *82 (personal ringing pattern) and *83 (ringing signal).

Activating/deactivating a discreet ring

You do not want to be disturbed by your phone ringing. However, you do not want to switch off your phone.

Discreet ringing is available on your phone as an alternative to the usual ringing. If discreet ring is activated, the phone rings only once.

This function must be stored under a Foxkey or a function key (see Chapter "[Configuring keys](#)", page 89).



In the idle state:

Press the function key for <*Discreet ring*>.
→ Discreet call is activated, 🎵 is displayed.

Suppressing your call number from your called party's terminal display

You do not want your call number to appear on the terminal display of a called party in the public network.

You have two possibilities:

- If you never want the phone number to be displayed, set *CLIR Permanent*.
- To suppress your call number display for certain calls only, select the function *CLIR Per call* before dialling your party's call number.

This function must be stored under a Foxkey or a function key (see Chapter "Configuring keys", page 89).

You can also execute the function with a function code (see "User's Guide Function Codes" on the Aastra 400 DocFinder: www.aastra.com/docfinder).



Before the call:

Press the function key for *<CLIR>*.

Notes:

- CLIR works only with external calls.
- This feature depends on the range of services offered by your provider.

Tracking a malicious call

You are being threatened or molested by a call. You want to identify the caller.

Using the *MCID* (Malicious Call Identification) function the provider records the following call data: Your phone number, the caller's phone number, and the date and time of the call.

MCID has to be enabled by your provider. Your provider will inform you about accessing the recorded call data.

This function must be stored under a Foxkey or a function key (see Chapter "Configuring keys", page 89).



During a call:

Press the function key for *MCID*.



After the call do not hang up: press the function key for *MCID* while you hear the busy tone.

Activating personal call routing

You want to specify which of your phone shall ring when you receive a call.

If your system administrator has set up a phone number with several phones for you as well as the 5 call routings, you can specify which of your phones shall signal a call by using the personal call routing. Your system administrator can set up up to 5 call routings. You can only answer a call on phone where the call is signalled. Contact your system administrator for more information.

You can activate a call routing for all phones. If you have not configured a call routing, the default setting (all phones are ringing) is used as standard.

This function must be stored under a Foxkey or a function key (see Chapter "Configuring keys", page 89).



Configuring personal call routing:

Configuring function key and selecting function:

Personal call routing: Activating a call routing.

Personal call routing menu: Overview menu.



Renaming personal call routing:

Press *Menu* > *Settings* > *General* > *Personal call routing* > *Modify*.



Activating personal call routing in idle state:

Press the function key for <*Call routing*>.

→ Personal call routing is activated.



Deactivating personal call routing in idle state:

Press the function key for <*Call routing*>.

→ Personal call routing is deactivated and the default setting activated.

Or:

You can deactivate the *Personal call routing* using *Menu* > *Activated features* > *Reset*.

Activating ring alone

You want to specify which of your phones shall ring acoustically when you receive a call.

When your system administrator has set up a phone number with several phones, you can define on which phones a call shall acoustically be signalled using ring alone.

When you have activated ring alone on a phone, the acoustic ringing tone is deactivated for all other phones (🔕). An incoming call is signalled in the display of all phones. You can answer the call on each of your phones.

Note:

When you have activated ring alone but deactivated the personal call routing for a phone in parallel, an incoming call is not acoustically but only visually signalled.

This function must be stored under a Foxkey or a function key (see Chapter "Configuring keys", page 89).

**In the idle state:**

Press the function key for <Ring alone>.

→ Ring alone is activated/deactivated.

Silent intrusion

Silent intrusion is a variant of the *Intrusion* function and is used mainly in call centres.

Another user can intrude on your active call and listen in to your conversation without you and your call party noticing. Unlike *Intrusion* you will receive neither a visual nor an acoustic signal.

This means you cannot reject *Silent intrusion*. The third user's microphone remains switched off. He can however intrude on the call at any time by enabling his microphone or pressing the *Intrusion* function key.

Your system administrator can allocate this function to a configurable key.

Notes:

- *Silent intrusion* has to be enabled. Contact your system administrator for more information.
- *Silent intrusion* may infringe on your national data protection provisions or be permitted only under certain circumstances.
- If you intend to use this function notify your call party in advance.



1. Enter the call number of the user you want.

2. Once the busy tone sounds, press key 4.

→ *Silent intrusion* is activated.

Free seating

You do not have your own workplace and share desk and phone with other employees.

Log in:

Free Seating lets you log in on a phone configured for that purpose. Once you are logged in, your personal call lists, phone book and all your other personal settings and Hotkeys are available to you immediately.

If your profile contains expansion key modules, but the phone you have logged in to does not, the keys in question will not be available to you. Various sequences of expansion key modules are correctly recognised.

Notes:

- You can only log in to a phone if no other user has yet logged in to that phone for free seating purposes.
- You can only log on once to a Free Seating phone. The moment you log in to another free seating phone, you are automatically logged off the original phone.

Log out:

To free up a phone, you need to log off again. To ensure a phone is not blocked for other users if you forget to log off, your system administrator can set up a logoff process with an automatic time limit:

- After a certain amount of time after login (e.g. after 6 hours and 30 minutes).
- At a certain time (e.g. 6.30 pm)

Notes:

- If no user is currently logged on to a Free Seating phone, depending on the system configuration only emergency calls can be made from that phone.
- As long as you do not have your own phone or are not logged on to a Free Seating phone, your caller will obtain either the busy signal or be forwarded to a preconfigured destination, depending on the system configuration.

Log in**Log in free seating:**

Press the *Log in* Foxkey.

Or:

Free seating can also be selected using the menu: *Menu > Settings > Log in*.

Enter phone number and PIN and confirm with the *Ok* Foxkey.

→ You are now logged in and can use the free seating phone with your personal settings.

Note:

The default PIN setting "0000" is not accepted. First change the PIN as described in chapter "Changing the PIN", page 80 or use function code *47 (see "User's Guide Function Codes" on the Aastra 400 DocFinder: www.aastra.com/docfinder). If you have forgotten your PIN, your system administrator can reset it to the default setting.

Log out**Log out free seating:**

Press the *Log out* Foxkey.

→ The display with the call number is displayed.

Depending on the system configuration enter the PIN and confirm with the *Ok* Foxkey.

→ You are now logged off; the free seating phone is now available again to other users.

Note:

You are automatically logged off if your system administrator has set up an automatic logoff process.

Setting functions by remote control

This section explains how you can alter your phone's settings even if you are not directly at your phone.

You are not at your desk and want to set various functions on your phone from a different phone.

You can activate/deactivate many of your phone's functions by remote control from a different phone.

The remote control is initiated using a special function code. You can then enter the function commands and function codes.

<Setting value>



Using remote control from a third-party phone:

1. Enter function code #06.
2. Enter your phone number.
3. Enter your PIN.
4. Enter the function code for activating/deactivating the function you want.

Pick up the handset.

→ You hear the acknowledgement tone.

Put the handset on-hook.

→ The function is now activated/deactivated.

Note:

The default PIN setting "0000" is not accepted. First change the PIN as described in chapter "Changing the PIN", page 80 or use function code *47 (see "User's Guide Function Codes" on the Aastra 400 DocFinder: www.aastra.com/docfinder). If you have forgotten your PIN, your system administrator can reset it to the default setting.

Organisation within the team

This section explains the different options provided by your phone to communicate in a team.

Using the Team key

You and your team partners want to be reachable at all times as a team and be able to communicate with one another as quickly as possible.

By pressing a single key you can call a team partner or answer a call for anyone in the team.

When a team partner makes a call, the corresponding Team key lights up; this tells you when a team partner is busy. The Team key flashes to indicate that the team partner is receiving a call.

If, for example, level 3 of the Aastra M535 expansion key module is activated and the Team key on level 1 receives a call, the call is signalled by the red blinking LED in position 1. For more information about the Aastra M535 expansion key module, please refer to chapter "[Using the Aastra M535 expansion key module](#)", page 21.

Calling a team partner

You want to call a team partner as quickly as possible.

Requirement: You have configured a configurable key as a Team key and stored the team partner's phone number under it (see Chapter "[Configuring keys](#)", page 89).



Press the Team key for the team partner.

→ The phone number and possibly the name of the team partner appear on the display. The team partner is called.

Substituting for a team partner

Your team partner is called. The Team key flashes. You know that your team partner is not at his desk at present and therefore decide to answer the call.

You can answer the call using the Team key. As soon as you have answered the call, your team partner is free again.



While the Team key is flashing:

Pick up the handset.

→ You hear the dialling tone.



Press the Team key.

→ You are through to the person who is calling your team partner.

Note:

Depending on the Team key's configuration, you are immediately connected with your team partner's caller as soon as you pick up the handset (see chapter "Store a team partner under a key – team key", page 92).

Starting an announcement to a team partner

You want to tell a team partner something without waiting for a reply.

With the Team key you can initiate an announcement to a team partner.

Requirement: It is essential that the team partner has not barred his phone against announcement (for configuration see the Chapter "Activating protection against call types", page 83).



Initiating an announcement to a team partner using a handset:

Pick up the handset.

→ You hear the dialling tone.

<twice short>



Press the Team key for the team partner twice in quick succession.

→ You hear the acknowledgement tone. The display shows *Announcement*.

You can start talking.

<twice short>



Initiating an announcement to a team partner using hands-free mode:

Press the Team key for the team partner twice in quick succession.

→ You hear the acknowledgement tone. The display shows *Announcement*.

You can start talking.

Note:

Depending on the Team key's configuration, you are immediately connected with your team partner's caller as soon as you pick up the handset (see chapter "Store a team partner under a key – team key", page 92).

Line keys

This section explains the different options provided by your phone, if your system administrator has assigned you one or more configurable keys as Line keys. Line keys turn your phone into a key phone.

A line has a number which can be used to make an external or internal call. One or usually several phones can be connected to this line, for example, in a travel agent's all the staff assigned to handling Europe as a travel destination. A Line key has an LED to indicate the line's status and lets you answer calls on that line.

If, for example, level 3 of the Aastra M535 expansion key module is activated and the Line key on level 1 receives a call, the call is signalled by the red blinking LED in position 1. For more information about the Aastra M535 expansion key module, please refer to chapter "[Using the Aastra M535 expansion key module](#)", page 21.

You are free to choose your own Personal key.

Answering a call on a Line key

You are called on one or more Line keys. The Line key(s) flash rapidly. You want to answer the call on one of the Line keys.

If you first want to answer a call on a different line key, press the line key to take the call. If you pick up the receiver without pressing a Line key, you are connected with the call on the line with the highest priority.



Pick up the handset.

→ Connection with the line with the highest priority.

Or:

1. Press the Line key.

→ The line is selected.

2. Pick up the handset.

→ Connection with the selected line.

Note:

If you keep the Line key pressed down for approx. 2 seconds while it is lit, the caller's phone number is displayed.

Making calls using the Line key

You want to make a call via a Line key.

You can make a call via any free Line key. Each Line key has its own phone number; in other words when you make a phone call you transfer the phone number belonging to the active Line key.

The call charges are recorded separately for each Line key.

<Phone number>



Enter the phone number.



Press a free Line key.

→The Line key is lit. The line is selected.



Pick up the handset.

→The phone number is dialled.

Note:

Depending on the configuration of a Line key the caller is called directly in hands-free mode (see chapter "Setting the Response of a Line Key", page 94).

Park call on Line key

You are connected with your call partner via a Line key and decide to park the call.

You can park your call partner on the current Line key.

Park



Park call:

Press the *Park* Foxkey.

→The Line key flashes slowly.



To retrieve a parked call:

Press the relevant Line key.

→You are now back through to the parked call partner.

Switching active lines

You are in a call and want to answer a call on another Line key or make a call.

You can switch lines by pressing a key. The active call is automatically parked locally.



Parking the call and switching lines:

Press the Line key you want.

→ The active call is parked. The call on the selected line is activated.



To retrieve a parked call:

Press the relevant Line key.

→ You are now back through to the parked call partner.

Note:

You cannot take a call on a line between two other call parties by pressing the corresponding Line key.

Personalizing your phone

These sections explain how to adapt the phone's basic settings to suit your personal requirements.

<i>Display</i>	73
<i>Setting the ringing properties (Audio)</i>	75
<i>Hands-free and headset settings</i>	77
<i>General settings</i>	79
<i>Protection settings</i>	83
<i>Phone Book Management</i>	84
<i>Configuring voice mail</i>	86
<i>Configuring presence</i>	87
<i>Configuring keys</i>	89
<i>Configuring Line Keys</i>	94
<i>Formulating functions</i>	96

Display

This section explains how to set display properties.

Setting the display

You may find the display is too bright or too dark.

You can adjust the *Display contrast*.

Menu



Press the *Menu* Foxkey.

Settings



Scroll to *Settings* and press the *Select* Foxkey.

Display



Scroll to *Display* and press the *Select* Foxkey.

<Display setting>



Scroll to the required display settings and press the *Modify* Foxkey.

<Setting value>



Select the required setting and confirm with the *Ok* Foxkey.
 → The setting is stored.

Ok



Hide "Wake-up call has expired"^[a]:

Press the *Ok* Foxkey.

→ Wake-up call status is set to OFF.

Delete



Delete "Wake-up call has expired"^[a]:

Press the *Delete* Foxkey.

→ In case of daily wake-up call, the wake-up call status is reset. Otherwise, the wake-up call status is set to OFF.

Setting the Aastra M535 display

You can adjust the *M353 display contrast*.

The backlight setting for the display of the Aastra M535 is taken from the phone.

Menu



Press the *Menu* Foxkey.

Settings



Scroll to *Settings* and press the *Select* Foxkey.

Display



Scroll to *Display* and press the *Select* Foxkey.

<Display setting>



Scroll to the required display settings and press the *Modify* Foxkey.
Select the required setting and confirm with the *Ok* Foxkey.
→ The setting is stored.

Setting the ringing properties (Audio)

This section explains how to set your phone's ringing tone properties.

Setting the ringing volume during ringing

You want to adjust the ringing volume.

You can adjust the ringing volume while the phone is ringing.

–|+ Quieter: Press the –-key.

–|+ Louder: Press the +-key.

Setting the volume during a call

You want to adjust the volume while in a call. You have to set the volume of handset and loudspeaker separately.

The new volume will remain stored even after the call is ended.

–|+ Quieter: Press the –-key.

–|+ Louder: Press the +-key.

Setting the ringing properties

You want to change the way in which your phone rings.

You can adjust the *Ringing volume*, the *Internal melody*, the *External melody*, and the *Speed*.

If you do not want to be disturbed during a certain time, you can set your phone not to ring with *Ring off*. Deactivated ringing is displayed with .

Note:

Please note that the ringing volume may be reduced if Aastra 5370 is not connected to the power supply.

Menu



Press the Menu Foxkey.

Settings



Scroll to *Settings* and press the *Select* Foxkey.

Audio



Scroll to *Audio* and press the *Select* Foxkey.

<Audio setting>



Scroll to the required audio settings and press the *Modify* Foxkey.

<Setting value>



Select the required setting and confirm with the *Ok* Foxkey.
→ The setting is stored.

Note:

To list to all the settings, use the *Test* Foxkey.

Hands-free and headset settings

This section explains other ways in which you can make calls with your phone.

Automatic hands-free mode

You want to answer a call without picking up the handset or pressing a key.

You can choose whether your phone should immediately and automatically activate hands-free operation after one ring, for internal calls or announcements.

Menu



Press the *Menu* Foxkey.

Settings



Scroll to *Settings* and press the *Select* Foxkey.

Audio



Scroll to *Audio* and press the *Select* Foxkey.

Autom. Hands-free



Scroll to *Automatic hands-free* and press the *Modify* Foxkey.

<Setting value>



Select the setting value for which you want to switch automatically to hands-free and confirm with the *Ok* Foxkey.

→The setting is stored.

To activate headset operation

You have connected a headset and now want to activate the headset mode.

A headset can be connected in parallel with the handset. You can switch the headset mode on and off.

If you answer a call in headset mode using the Call key or Loudspeaker key, the call is provided on the headset. Alternatively you can also answer the call by picking up the handset.

This phone supports headsets based on the DHSG standard, which allows you to set up and to end calls from the headset. Ask your dealer which headsets are particularly well suited for this phone.

Notes:

- To avoid damages on the phone always disconnect the phone from the mains power first before you install a DHSG (Digital Hook Switch) headset.
- To find out how to make phone calls with the headset, refer to the Chapter "Using a headset", page 18.

Menu



Press the *Menu* Foxkey.

Settings



Scroll to *Settings* and press the *Select* Foxkey.

Audio



Scroll to *Audio* and press the *Select* Foxkey.

Headset



Scroll to *Headset* and press the *Modify* Foxkey.

<Setting value>



Activate/deactivate the headset mode and confirm with the *Ok* Foxkey.
→ The microphone is deactivated,  is displayed.

General settings

This section explains other settings you can make on your phone.

Selecting the language

The display text is not in the language you want.

You can select a different language. The menu item under which you select your language is marked by an "*" in front of the word for "language" in the language of your choice, e.g. "*Language" for English.

- Menu*



Press the *Menu* Foxkey.
- *Language*



Scroll to **Language* and press the *Modify* Foxkey.
 →The set language is displayed with .
- <Setting value>



Select the required language and confirm with the *Ok* Foxkey.
 →The display text appears in your selected language.

Configuring the DTMF mode

You want to decide whether the DTMF mode is to be activated or deactivated as default on your phone.

- Menu*



Press the *Menu* Foxkey.
- Settings*



Scroll to *Settings* and press the *Select* Foxkey.
- General*



Scroll to *General* and press the *Select* Foxkey.
- DTMF*



Scroll to *DTMF* and press the *Modify* Foxkey.
- <Setting value>



Activate or deactivate DTMF and confirm with the *Ok* Foxkey.
 →The setting is stored.

Changing the PIN

You want to change the PIN used to lock/unlock your phone (see Chapter "[Locking your phone](#)", page 49 and "[Unlocking your phone](#)", page 50).

The digit combination "0000" is set as default. You can select any 2 to 10-digit combination for your new PIN.

If you have forgotten your PIN, your system administrator can reset it to the default setting. Depending on the system settings the function may not be available.

Note:
Your PIN applies to all your phones.

Menu



Press the *Menu* Foxkey.

Settings



Scroll to *Settings* and press the *Select* Foxkey.

General



Scroll to *General* and press the *Select* Foxkey.

PIN



Scroll to *PIN* and press the *Modify* Foxkey.

→ The display shows *Old PIN*.

<Old PIN>



Enter the old PIN and confirm with the *Ok* Foxkey.

→ The display shows *New PIN*.

<New PIN>



Enter the new PIN and confirm with the *Ok* Foxkey.

→ The display shows *Confirm*.

<New PIN>



Enter the new PIN a second time and confirm with the *Ok* Foxkey.

→ The new PIN is stored.

Notes:

- For each digit entered, the display shows an "*".
- You can also change the PIN with function code *47 (see "User's Guide Function Codes" on the Aastra 400 DocFinder: www.aastra.com/docfinder).

Enter the display text for the idle state

You want to change the text displayed by your phone in the idle state.

In addition to the date and time you can enter a personal text for the text displayed in the idle state.

- Menu*



Press the *Menu* Foxkey.
- Settings*



Scroll to *Settings* and press the *Select* Foxkey.
- General*



Scroll to *General* and press the *Select* Foxkey.
- Idle text*



Scroll to *Idle text* and press the *Modify* Foxkey.
- <Text>

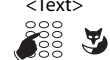

Enter the text and confirm with the *Ok* Foxkey.
 → The text is stored.

Notes:

- The text mode for letter input is automatically activated.
- You can use the Correction key to delete any incorrect character.

Activating screensaver (only Aastra 5370ip)

You want to activate the screensaver, which your phone displays some minutes after the idle state.

As screensaver, you can select between clock round and square.

- Menu*



Press the *Menu* Foxkey.
- Settings*



Scroll to *Settings* and press the *Select* Foxkey.
- Display*



Scroll to *Display* and press the *Select* Foxkey.

Screensaver



Scroll to *Screensaver* and press the *Modify* Foxkey.

<Setting value>



Activating screensaver (with the clock type you want) or deactivating and confirm with the *Ok* Foxkey.

→The setting is stored.

Identifying the communication system

This phone can be connected to different Aastra communications systems. You can verify to which system your phone is connected to.

Menu



Press the *Menu* Foxkey.

Settings



Scroll to *Settings* and press the *Select* Foxkey.

General



Scroll to *General* and press the *Select* Foxkey.

Own ID



Scroll to *Own ID* and press the *Select* Foxkey.

→Name, call number and communication system are displayed.

Local IP settings (Aastra 5370ip)

The IP-relevant data for your phone is stored in this menu. The input of this data is password-protected; it can therefore only be carried out by your system administrator. You can however call up the data.

Menu



Press the *Menu* Foxkey.

Settings



Scroll to *Settings* and press the *Select* Foxkey.

General



Scroll to *General* and press the *Select* Foxkey.

Local settings



Scroll to *Local settings* and press the *Select* Foxkey.

→IP-relevant settings retrievable.

Protection settings

This section explains how you can protect yourself against certain types of call.

Activating protection against call types

You want to protect yourself against certain types of calls.

You can set the settings so that the following functions are not allowed on your phone:

- **Do not disturb:** Incoming calls are automatically forwarded to a specific destination.
- **Call waiting:** You are already making/taking a call. You are notified by a waiting tone and phone number or name in the display that someone else is trying to reach you. You can either answer or reject this second call.
- **Intrusion:** A third participant can intrude into your active call and listen to your conversation.
- **Announcement:** You can address internal users directly via their loudspeaker – where available –, without waiting for a reply (similar principle to that of an intercom system).
- **Forwarding:** Incoming calls are forwarded directly to your phone.

Ask your system administrator whether these functions are enabled on the system.

Menu



Press the **Menu** Foxkey.

Settings



Scroll to **Settings** and press the **Select** Foxkey.

Protection



Scroll to **Protection** and press the **Select** Foxkey.

<Protection setting>



Scroll to the required protection settings and press the **Modify** Foxkey.

<Setting value>



Select the required setting and confirm with the **Ok** Foxkey.
 → The setting is stored.

Note:

You can deactivate an activated protection using **Menu > Activated features > Foxkey Reset**.

Phone Book Management

This section explains how to create a new entry in the phone book and how to edit or delete an entry.

Creating a new phone book entry

You want to store your own phone numbers. You can store your own phone numbers in the private phone book.

You may store several phone number entries (business, private, mobile) to one contact. Define one of these numbers as default phone number to be used when you do not pick a specific entry.

For the communication system (communication server, OIP, Microsoft Outlook, Twix-Tel) to identify an external number it is recommended to enter the number in canonical format (+Country Code (Region Code) Phone Number). Press the + key to insert +. You can store the phone number in one of the following formats:

- 0-004132655xxxx
- 004132655xxxx
- 9-004132655xxxx
- +41 (32) 655xxxx



Press the phone book key.

Private contacts



Scroll to *Private contacts* and press the *Select* Foxkey.

New



Press the *New* Foxkey.

Save



Enter the contact data (name, business, mobile, private) of the user. Use the navigation key to scroll between the entries. Press the End key if you want to close the entry without saving.

Confirm with the *Save* Foxkey.

→ The contact is now stored.

Default



Specifying the default number:

1. Select the contact you want.
2. Use the right navigation key to open the contact and highlight the call number you want.
3. Specify the selected phone number as default number using the *Default* Foxkey.

Editing or deleting a phone book entry

You want to modify a phone number stored on your private phone book.

Note:

You cannot modify entries in other phone books.



Press the phone book key.

Private contacts



Scroll to *Private contacts* and press the *Select* Foxkey.

<Entry>



Changing an entry:

Select the entry you want and press the *Edit* Foxkey.

<Name, phone number>



Modify the contact data and confirm with the *Ok* Foxkey.

<Entry>



Deleting an entry:

Select the entry you want and press the *Delete* Foxkey.

→The entry is now deleted.

Storing the phone number in the phone book from the call list

You want to store a phone number from one of the call lists in your private phone book.

You can add a phone number to an existing contact or create a new contact.

Menu



Press the *Menu* Foxkey.

Call lists



Scroll to *Call lists* and press the *Select* Foxkey.

<Call list>



Select the call list and the user you want and press the *Save* Foxkey.

<Entry>



Adding to existing contact:

Press the *Add to exist. contact* Foxkey, select the contact and number type you want and confirm with the *Save* Foxkey.

<Entry>



Adding new contact:

Press the *Add new contact* Foxkey, select the number type you want and confirm with the *Save* Foxkey.

Configuring voice mail

This section explains how to set your voice mail.

Managing personal greeting

You have the possibility to record up to 3 different greetings (e.g. for Absent or Vacation). Give each greeting the relevant name.

Depending on the system configuration a caller may or may not be able to leave a message (for the symbols see Chapter "Display symbols", page 4).

If no personal greeting is activated or if none is available, the global greeting is activated automatically, provided it has been recorded. Contact your system administrator for more information.

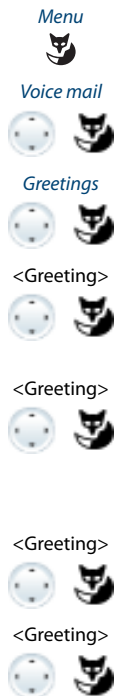

Press the **Menu** Foxkey.

Scroll to **Voice Mail** and press the **Select** Foxkey.

Scroll to **Greetings** and press the **Ok** Foxkey.

Renaming greeting:

Select the greeting you want and press the **Edit** Foxkey.

→ Give each of your personal greetings the relevant name and confirm with **Ok**.

Recording a greeting:

Select the greeting you want and press the **Record** Foxkey.

→ Now record your personal greeting text.

Note:

You can improve the voice quality by recording the text through the handset.

Listening to the greeting:

Select the greeting you want and press the **Listen** Foxkey.

→ You can monitor your personal greeting text and re-record it if necessary.

Selecting the greeting:

Select the greeting you want and confirm with the **Ok** Foxkey.

→ The announcement last recorded is automatically activated.

Notes:

- To find out how to configure call forwarding to your voice mail, refer to the Chapter "Forwarding to voice mail", page 46.
- For further information on voice mail refer to the "User's Guide Voice Mail Systems" on the Aastra 400 DocFinder: www.aastra.com/docfinder.

Configuring presence

You can to control your current presence status (see Chapter "Organizing absences using the presence key", page 42).

You have a choice of 5 presence profiles for controlling your presence status. For each of these presence profiles you can make the following settings:

- **Description:** Type in the text you want to be visible to other users as detailed information on your presence status (e.g. the name of your substitute).
- **Date/time:** choose whether the absence information should be given *without date/time* or with *date/time*.
- **Personal call routing:** Specify the phones on which a call is to be signalled (see Chapter "Activating personal call routing", page 62).
 - **Keep settings as is:** Calls are routed according to your settings.
 - **Call routing-ID <1...5>:** your personal call routing number.
- **Call forwarding:** Specify where you want a call to be forwarded to (see Chapter "Forwarding calls (Call forwarding)", page 44).
 - **Keep settings as is:** Calls are routed according to your settings.
 - **No forwarding:** any configured call forwarding operation is deleted.
 - **User:** a call is channelled to the defined forwarding destination.
 - **Voicemail:** a call is forwarded to voicemail. The greeting to be played back can be configured with Voice mail greeting.
- **Voice Mail greeting**
 - **Keep settings as is:** your currently defined greeting is used.
 - **Absence information:** your caller is given an absence information (as well as date and time, if this has been configured as such in the presence profile).
 - **Standard greeting:** the global greeting is played back to your caller.
 - **Personal greeting** (if your personal greeting has been renamed, this name is displayed in the options): one of the personal greetings is played back to your caller.



To open the presence menu:

Press the presence key.

Or:

Press the function key for <Presence menu> (for storing under a function key see Chapter "Store a function under a key – function key", page 91).

Or:

The presence menu can also be selected using the menu: *Menu > Settings > General > Presence*.

→ Presence menu is displayed.

Modify



Set the function key for presence profile:

1. Open the presence menu, scroll to the profile you want and press the *Modify* Foxkey.
2. Make the setting you want and confirm with the *Ok* Foxkey.
→The profile has been changed.

Modify



To change the presence profile:

1. Open the presence menu, scroll to the profile you want and press the *Modify* Foxkey.
2. Make the setting you want and confirm with the *Ok* Foxkey.
→The profile has been changed.

Configuring keys

This section explains how to assign phone numbers and functions to a Foxkey or configurable key.

Available keys

You can store phone numbers or functions under two different keys:

- on a configurable key or a presence key – retrievable at any time
- directly on the Foxkey itself – retrievable only in the idle state

You can assign each key with a specific type so you can trigger a particular action by simply pressing that key. Choice available:

- Number key: storing the phone number;
- Function key: activate/deactivate function;
- Team key: Organisation within the team;
- Line key: Setting up a key phone (Line keys must be set up by your system administrator).

Note:

For more information about the Aastra M535 the expansion key module, see chapter "Using the Aastra M535 expansion key module", page 21 and "Aastra M530/Aastra M535 expansion key module (optional)", page 108.

Store a phone number under a key – number key

You want to retrieve a frequently used phone number with a single keystroke rather than enter it digit by digit.

On each Foxkey you can store one number and name, and on each configurable key you can store two call numbers and the associated names. The key automatically becomes a number key.

Menu



To store a phone number under the Foxkey:

Press the *Menu* Foxkey.

Settings



Scroll to *Settings* and press the *Select* Foxkey.

Keys > Foxkey



Scroll to *Keys > Foxkey* and press the *>Select* Foxkey.

→ Display shows choice of key types.

Number key



Scroll to *Number key* and press the *Select* Foxkey.

Enter phone number and name and confirm with the *Ok* Foxkey.

→ The phone number is now stored.

<long>



To store a phone number under a configurable key/presence key:

Press the key and hold it down for a moment.

→ Display shows choice of key types.

Number key



Scroll to *Number key* and press the *Select* Foxkey.

Enter phone numbers and names and confirm with the *Ok* Foxkey.

If you have an Aastra M535 expansion key module connected, you can also select the number type (*Business number*, *Mobile number* or *Private number*).

Notes:

- The text mode for letter input is automatically activated.
- You can use the Correction key to delete any incorrect character.
- You can store only one call number on a configurable key of the Aastra M535 expansion key module.

Store a function under a key – function key

You want to retrieve a frequently used function - for example "call forwarding on no reply" - using a single keystroke rather than having to enter it by hand. Usually the function is assigned so that you:

- activate the function with the first keystroke – key-LED lit,
- and deactivate the command again with a second keystroke - key-LED off.

Menu



Storing a function under the Foxkey:

Press the *Menu* Foxkey.

Settings



Scroll to *Settings* and press the *Select* Foxkey.

Keys > Foxkey



Scroll to *Keys > Foxkey* and press the *>Select* Foxkey.

→ Display shows choice of key types.

Function key



Scroll to *Function key* and press the *Select* Foxkey.

→ The currently set function is displayed with

<Function>



Select the function you want and press the *Select* Foxkey.

→ The further prompting depends on the function (see Chapter "Supplementary features", page 26). Once you have made all the settings, the function is stored under the key.

Note:

Besides the predefined functions you can also specify your own function. For more information please refer to the Chapter "Function commands", page 96.

<long>



Storing a function under a configurable key/presence key:

Press the key and hold it down for a moment.

→ Display shows choice of key types.

Function key



Scroll to *Function key* and press the *Select* Foxkey.

→ The currently set function is displayed with

<Function>



Select the function you want and press the *Select* Foxkey.

→ The further prompting depends on the function (see Chapter "Supplementary features", page 26). Once you have made all the settings, the function is stored under the key.

Note:

Besides the predefined functions you can also specify your own function. For more information please refer to the Chapter "Function commands", page 96.

Store a team partner under a key – team key

Together with other members you wish to organise yourself into a team so that on the one hand you can always be reached as a team and, on the other, to ensure mutual substitution. You can configure a configurable key as a Team key and then assign it to a team partner. One team key is configured for each team member, allowing you:

- to call one another with a single keystroke;
- to answer an incoming call for another team member with a single keystroke;
- and to select whether the flashing team key should be complemented by a ringing tone whenever a team partner is called. You can configure a ringing delay for the ringing tone;
- to choose between answering directly using automatic hands-free operation, picking up the handset, and pressing the Team key.

The following audio settings are possible: *Ring, Melody, Speed, Answer*.

Notes:

- A Team key can only be allocated to a configurable key.
- To find out how to use a Team key, refer to the Chapter "Using the Team key", page 67.

<long>



Press the configurable key and hold it down for a moment.
→ Display shows choice of key types.

Team key



Scroll to *Team key* and press the *Select* Foxkey.

<Phone number,
name>

Entering or editing phone number. If the user is stored in the system, the name is automatically entered. Confirm with the *Ok* Foxkey.
→ The display shows the properties with which you can configure the team key.

<Audio settings>



Set the Audio settings:

Scroll to the required audio settings and press the *Modify* Foxkey. Select the required setting and confirm with the *Ok* Foxkey.
→ The setting is stored.

Setting possibilities for ringing:

- *Off* for no ringing tone, *On* for instant ringing tone, and ringing tone *Del 10s*, *Del 20s* and *Del 30s* and confirm *Ok* with the Foxkey.
- You can listen to each setting using the *Test* Foxkey.

Answer



Setting the answering mode:

Scroll to *Answer* and press the *Modify* Foxkey.

Select the required setting and confirm with the *Ok* Foxkey.

→ The setting is stored.

Setting possibilities for answering:

Key to answer the call by pressing the Team key, *Handset* to answer by picking up the handset, and *Hands-free* to answer automatically with hands-free.

Notes:

- The *Handset* and *Hands-free* settings only work when the ringing signal is activated.
- If you select answer using *Handset* or *Hands-free*, you must also specify the *Priority*, with 1 being the highest priority, and 8 the lowest:

Clearing a key

You want to clear the assignment made to a configurable key.

Select the function *No function* to delete the function key assignment.

<long>



To clear the Foxkey:

Press the Foxkey with a long keystroke.

→ The display shows the key type.

Scroll to *No function* and confirm with the *Ok* Foxkey.

→ The key configuration is cleared.

No function



<long>



To clear a configurable key:

Press the configurable key and hold it down for a moment.

→ The display shows the key type.

Scroll to *No function* and confirm with the *Ok* Foxkey.

→ The key configuration is cleared.

No function



Configuring Line Keys

This section explains how to adapt your Line key settings to suit your personal requirements.

Your system administrator will determine whether your phone has Line keys.

Setting the Response of a Line Key

You want to set the response of a line key.

You can choose whether you also want a ringing signal in addition to the flashing Line key when you receive a call on a Line key. You can configure a ringing delay for the ringing tone.

To answer a call you can choose between answering directly by pressing the Line key, picking up the handset, and using automatic hands-free operation.

Answering an external call using automatic hands-free operation is not available.

The following audio settings are possible: *Ring*, *Melody*, *Speed*, *Answer*.

Notes:

- A Line key can only be allocated to a configurable key.
- To find out how to use a line key, refer to the Chapter "Line keys", page 69.



Press the Line key you want and hold it down for a moment.

→ The display shows the Line key and the properties with which you can configure the Line key.

Note:

The Personal key is also treated as a line key.

Line key



Scroll to *Line key* and press the *Select* Foxkey.

<Audio settings>



Set the Audio settings:

Scroll to the required audio settings and press the *Modify* Foxkey. Select the required setting and confirm with the *Ok* Foxkey.

→ The setting is stored.

Setting possibilities for ringing:

- *Off* for no ringing tone, *On* for instant ringing tone, and ringing tone *Del 10s*, *Del 20s* and *Del 30s* and confirm *Ok* with the Foxkey.
- You can listen to each setting using the *Test* Foxkey.

Answer



Setting the answering mode:

Scroll to *Answer* and press the *Modify* Foxkey.

Select the required setting and confirm with the *Ok* Foxkey.

→ The setting is stored.

Setting possibilities for answering:

Key to answer the call by pressing the line key, *Handset* to answer by picking up the handset, and *Hands-free* to answer automatically with hands-free.

Notes:

- The *Handset* and *Hands-free* settings only work when the ringing signal is activated.
- If you select answer using *Handset* or *Hands-free*, you must also specify the *Priority*, with 1 being the highest priority, and 8 the lowest.

Formulating functions

This section explains how to activate an individual function, for example call forwarding unconditional, with the aid of function commands and function codes and how to assign it to a key.

Function commands

You can use function commands to define a function to suit your personal requirements. A function can consist of one or more function commands, function codes, and the phone number. You can either carry out a function directly or store it under a function key (select *configurable* function).

Tab. 1 The following function commands are available:

"A"	Seize line with highest priority
"I"	Seize line
"X"	Disconnect
"P"	1Pause 1 second before the next operation
"Lxx"	Seize line xx (Line keys)
"N"	Use the phone number entered in call preparation
"."	Control key function (up-circuit system)
"Z"	Activate/deactivate DTMF mode
"R"	Use the phone number last dialled
"Y"	Disconnect and reseat the line

Tab. 2 Examples of how to define a function:

"IR"	Seize line ("I"), Dial phone number last dialled ("R")
"I201"	Seize line ("I") and dial phone number 201
"I*21201X"	Seize line ("I"), activate call forwarding unconditional ("*21") to phone number 201, disconnect ("X")
	<p>Notes:</p> <ul style="list-style-type: none"> • Text mode has to be activated before you can enter function commands. • Functions that are not available via the menu can be activated using function codes (see "User's Guide Function Codes" on the Aastra 400 DocFinder: www.aastra.com/docfinder). • You can either type in a function command or code directly or store it under a key. • You can only activate certain function codes if the same function cannot be obtained via the menu. • The availability of certain function code may be restricted depending on the system and software version.

Function codes

A list with all the function codes can be found in the "User's Guide Function Codes" on the [Aastra 400 DocFinder](#).

Installation and first-time operation

These sections explain the setup options available with your phone.

<i>Equipment provided</i>	99
<i>Options</i>	100
<i>Setting up and mounting the phone</i>	101
<i>Connect Aastra 5370</i>	105
<i>Connect Aastra 5370ip</i>	106
<i>Aastra M530/Aastra M535 expansion key module (optional)</i>	108
<i>Labelling the Aastra M530 expansion key module</i>	110

Equipment provided

Telephone and handset



Handset connection cable



Telefonanschlusskabel Aastra 5370

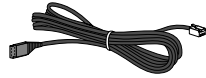

Stand rest; can also be used as a mounting frame for wall mounting

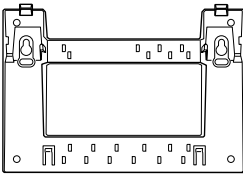

Quick User's Guide and safety information



Options

Plug-in power adapter

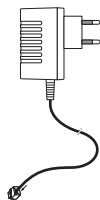

Expansion key module Aastra M530 with write-on labels (incl. stand rest and connection cable)

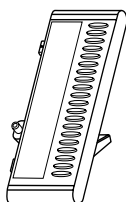

Expansion key module Aastra M535 with display (incl. stand rest and connection cable)

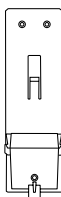
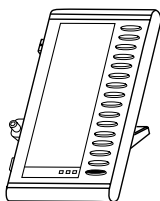

Setting up and mounting the phone

With the aid of the supplied stand rest you can set up the phone as a desk phone or mount it to the wall.

Setting the phone up as a desk phone

You can set up the phone either at a 40° or a 25° angle. To do so, insert the stand rest in different positions into the back of the phone until it snaps into place.

- Insert the stand rest as indicated on the installation diagram until it snaps into place.
- Connecting the handset: Plug the connector on the shorter straight extremity of the handset cord into the socket on the handset. Plug the connector at the loose extremity of the cord into the handset socket on the underside of the phone. To relieve the strain on the cable feed the cable through one of the cable guides on the stand rest.
- Connect the phone as indicated in chapter "[Connect Aastra 5370](#)", page 105 and "[Connect Aastra 5370ip](#)", page 106.

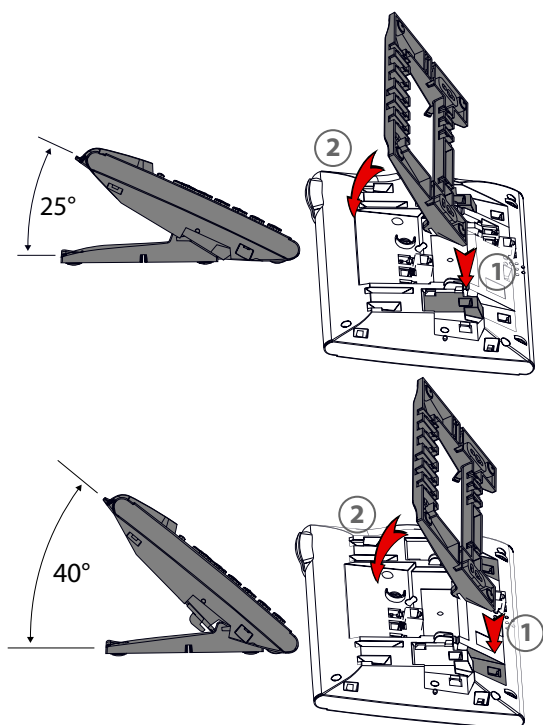

Wall mounting

You can also mount the phone on the wall. To do so, screw the stand rest onto the wall as a bracket and hook the phone onto the stand rest.

Notes:

- As there is only a limited amount of space between the sockets on the back of the phone and the wall on which it is mounted, you need to use a ribbon cable with a short connector for the cord. Ask your dealer for a list of suppliers for a suitable ribbon cable (only Aastra 5370ip).
 - You can only connect one Aastra M530 and one Aastra M535 (option) if the phone is wall-mounted.
- Fit the screws for securing the stand rest and mount the stand rest (Figure A).
 - Connect the handset and phone cord to the phone (Figure B). For the correct connection assignment refer to Chapter "[Connect Aastra 5370](#)", page 105 and "[Connect Aastra 5370ip](#)", page 106.
 - Insert the phone into the stand rest horizontally (Figure C-1) and slide downwards (Figure C-2).
 - Unscrew the cams for holding the handset (Figures D-1 to D-3).
 - Insert the handset.

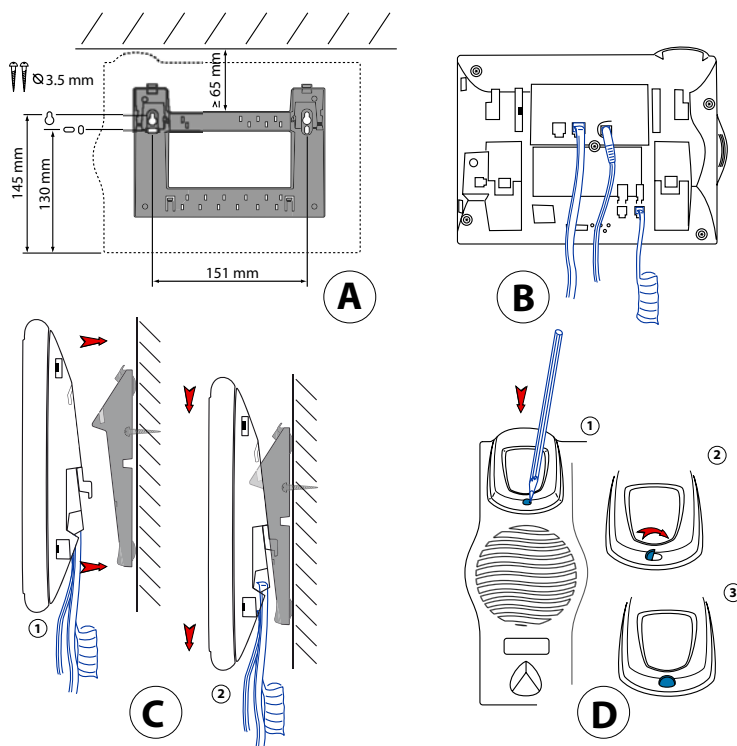

Dismantling

Desk phone:

- Disconnect the phone cord and remove.
- Carefully pull the stand rest away in the opposite direction.

Wall set:

- Carefully slide the phone upwards out of the stand rest.
- Disconnect the phone cord and remove.

Connect Aastra 5370

Connections



Telephone connection



Connecting the handset



Headset connection



Connecting the Aastra M530/Aastra M535 expansion key module or power supply

Connecting your phone to the system

- Plug the connector on the phone cord on the underside of the phone into the socket with the phone symbol.
- Desk installation only: To relieve the strain on the cable feed the cable through one of the cable guides on the stand rest.
- Plug the other end of the cable into the phone socket outlet.
- Set channel selector switch on the underside of the phone. Contact your system administrator for more information.

Logging your phone on

Your system administrator has to prepare the system before you can log on your phone.

Connect Aastra 5370ip

IP connections

LAN Connecting to the IP network

PC \times Connecting a PC (if required)



Connecting the handset



Headset connection



Connecting the power supply



Connecting the Aastra M530/Aastra M535 expansion key module

Note:

Your system administration will take care of the IP addressing and the commissioning of the phone. The IP addresses and other information about your phone is available in the setting mode.

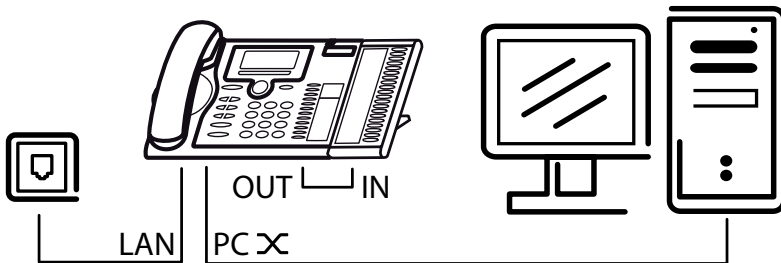

Connecting your phone to the LAN

This phone communicates via the same connection as your PC (IP network / LAN). This means you do not need a special phone connection. Ask your system administrator if you have any doubts about your phone's connection.

- Connecting the LAN cord (not included in the scope of delivery) to a LAN socket.

- Plug the connector at the loose end on the underside of the phone into the LAN socket.
- Desk installation only: To relieve the strain on the cable feed the cable through one of the cable guides on the stand rest.

Connecting your PC to the LAN

If required, you can connect your PC or another LAN device to the phone, for example a printer.

- Connecting the LAN cord (not included in the scope of delivery) to the PC's network socket.
- Plug the connector at the loose end on the underside of the phone into the PC socket.
- Desk installation only: To relieve the strain on the cable feed the cable through one of the cable guides on the stand rest.

Connecting the power supply

If your LAN supports Power-Over-Ethernet (PoE), the phone will be powered via the LAN cord and you will not require a power adapter.

If your LAN does not support PoE or if you have installed a switch between the LAN and the phone that does not support PoE, you will need the optional power adapter to power the phone.

Note:

Only use the optional original plug-in power adapter.

- Plug the round connector of the power cord on the underside of the phone into the power socket.
- Desk installation only: To relieve the strain on the cable feed the cable through one of the cable guides on the stand rest.
- Connect the power supply to the mains power.

Logging the IP phone

Your system administrator has to prepare the system before you can log on your phone.

Aastra M530/Aastra M535 expansion key module (optional)

You can connect 1 Aastra M530 expansion key module with 20 configurable keys or 1 Aastra M535 expansion key module with 3 x 15 configurable keys to your phone. Each key has an LED for visual signalling.

Connections

IN

Connecting the Aastra M530/Aastra M535 expansion key module



Connecting further Aastra M530/Aastra M535 expansion key modules (symbol on Aastra M530)



Connecting further Aastra M530/Aastra M535 expansion key modules or power supply (symbol on Aastra M535)

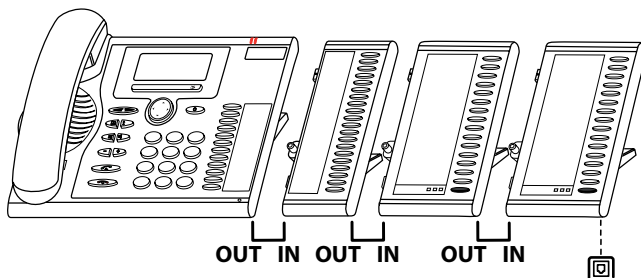

Connecting the Aastra M530/Aastra M535 expansion key module

Note:

Always disconnect the phone from the mains power first before you connect/disconnect an Aastra M530/Aastra M535 expansion key module.

- Unplug the phone cord from the socket on the underside of the phone.
- Attach Aastra M530/Aastra M535 expansion key module to the right of the phone until you feel and hear it snap into place, as indicated in the following figure.
- Plug the cord into the supplementary equipment sockets on the underside of the phone and the Aastra M530/Aastra M535 expansion key module.
- Feed the connecting cable through the strain relief on the underside of the Aastra M530/Aastra M535 expansion key module.
- Plug the phone cord back into the socket on the underside of the phone. The expansion key module Aastra M530/Aastra M535 is now ready for operation.
- Depending on the type of power supply, you may need an additional power supply unit for your expansion key module. If there is an under supply of power, a message appears on the display. Contact your system administrator for more information.

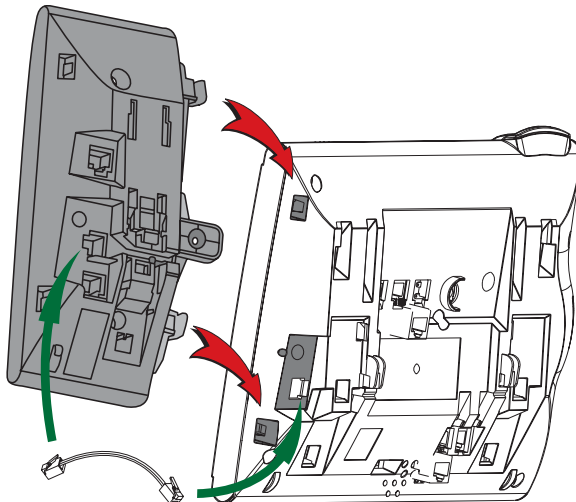

Labelling the Aastra M530 expansion key module

Write-on labels for the configurable keys can be found on the [Aastra 400 Doc-Finder](#).

You can fill out the fields directly on your PC and then print out the labels.

- Label the write-on labels on the PC, print them ("Page scaling for printing: none) and cut them out.
- Carefully remove the transparent cover next to the configurable keys.
- Place the write-on labels into the recesses next to the configurable keys.
- Carefully replace the transparent cover.

Further information

The following sections contain more useful information about your phone.

<i>Troubleshooting</i>	112
<i>Declaration Open Source Software (Aastra 5370ip)</i>	113
<i>Communication system and software versions</i>	114

Troubleshooting

This section contains a few tips on how to operate your phone if you encounter any problems.

Malfunctions

Your call partner cannot hear you or you cannot hear your call partner

Make sure the handset cord is correctly plugged into both the handset and the phone (see chapter "Installation and first-time operation", page 98).

Handset off-hook, no dialling tone, no display

Make sure the phone cord is correctly plugged in to both the phone and the LAN socket (see chapter "Installation and first-time operation", page 98).

Display shows "Not configured", handset off-hook, no dial tone

Your phone has not been assigned a call number. Contact your system administrator for more information.

Display shows: "Trying to register"

The telephone cannot be registered. Contact your system administrator for more information.

Display is working, but connection is not possible

Your phone may be locked. Unlock your phone (see Chapter "Unlocking your phone", page 50).

Freely configurable keys cannot be configured

The configuration may be locked. Unlock your phone (see Chapter "Unlocking your phone", page 50). The key for a reconfiguration may be locked in the system. Contact your system administrator for more information.

The expansion key module Aastra M530/Aastra M535 possibly has not sufficient power supply. Contact your system administrator for more information.

Insufficient display contrast

The setting for the display contrast is inadequate. Change the setting (see Chapter "Setting the display", page 73).

Impaired sound quality during hands-free operation

The sound quality can be affected if the volume is too loud – turn down the volume. If the sound quality fluctuates, contact your system administrator.

Only emergency calls are possible

You may want to telephone from a Free Seating phone, but have not logged on to it. Log on to the phone (see Chapter "Free seating", page 64).

Phone calls can be made, but no names are displayed; the key configuration is missing, and the phone does not respond to function commands

Restricted mode following a software update without update licence.

Note:

For all other messages, faults and questions you may have, contact your system administrator.

Declaration Open Source Software (Aastra 5370ip)

About Open Source Software

This product contains Open Source Software from third-party suppliers subject to the GNU licence provisions GPL (GNU General Public License) and LGPL (GNU Library/Lesser General Public License).

The licence texts for the GPL and LGPL and for the source code of the software sections listed below are available at www.aastra.com/docfinder ("Public GNU source" document type).

The licence texts for the GPL and LGPL are also stored on the phone itself and can be viewed using the integrated web interface (URL: <IP address of your phone>).

Please read through the text carefully to find out all you need to know about your rights with regard to the licences concerned.

This product contains the following software subject to GPL provisions:

- Linux kernel, available at www.kernel.org/
- Busybox, available at www.busybox.net/

This product contains the following software subject to the LGPL provisions:

- uClibc, available at www.uClibc.org/

Communication system and software versions

You want to activate a feature described in these Instructions but the system will not let you.

Some communication systems or software versions do not support all the features. The corresponding text sections are identified by a letter inside square brackets [a]. The list below indicates which system versions support the relevant features. Contact your system administrator for more information.

	R2.0							
[a]	X							
[b]								
[c]								
[d]								

Index

A

Absence information	48
Accessories (Safety information)	6
Activating screensaver	81
Alphasearch	28
Ambient conditions (Safety information)	6
Announcement:	
Protection setting	83
receiving	36
starting	35
Audio	75
Automatic hands-free mode	77

B

Brokering	38
-----------------	----

C

Call duration	14
Call Forwarding on No Reply	45
Call Forwarding Unconditional	44, 47
Call key	3
Call list	30
Call routing	62
Call waiting:	
answering	34
on an internal user	33
Protection setting	83
Call:	
end	14
take	14
Callback:	
answering	33
requesting	32
Changing the PIN	80
Charges	14, 36, 58
CLIP	61
CLIR	61
Communication system	82, 114
Communication system and software versions ...	9
Conference call	38
Configurable key	3
Configuring Line keys	94
Configuring presence	87
Configuring the DTMF mode	79
Connect	39

Connecting:

IP phone	106
IP phone to the LAN	106
PC to LAN	107
Phone	105
Power supply	107
to the system	105
Connections (Safety information)	6
Correcting your input	23
Correction key	2
Cost control (Safety information)	6

D

Data protection (Safety information)	6
Deflect	53
Deflect a call during the ringing phase	53
Deflecting voice messages	55
Desk phone	101
Dialling by name	28
Dialling:	
by name	27
from call list of answered calls	30
from call list of unanswered calls	30
from external phone books	29
from the phone book	28
with a configurable key	32
with configurable Foxkey	31
with phone number	15
with redial	16, 31
Digit keys	22
Discreet ringing	60
Dismantling	104
Display symbols:	
Aastra M535	5
Phone	4
Display text for the idle state	81
Display:	
Display contrast	73
Display symbols	20
Display text	20
M535 display contrast	74
set	73
Disposal (Safety information)	6
Do not disturb:	
Protection setting	83

Document information	10
DTMF	58, 79

E

End key	3
Enquiry call during a call	37
Enter the letters	22
Enters digits	22
Equipment provided	99
Exclusion of liability	10
Expansion key module:	
Aastra M530/Aastra M535	108
connect	108
Connections	108
LED	21
using	21

F

First-time operation	98
Formulating functions	96
Forwarding:	
Call Forwarding Unconditional	44
Forwarding calls	45
Protection setting	83
to a message	47
to voice mail	46
Foxkey	2
Free seating	64
Function codes	97
Function commands	96
Function key	91
Function selection for configurable key	51

G

General bell:	
answering	60
Searching for a user	59
GNU licence provisions	113

H

Hands-free microphone	2
Hands-free operation	17, 77
Headset	18

I

Indicator LED	25
Installation	98
Intrusion:	
Protection setting	83

K

Key block	2
Key legend:	
Aastra 5370/5370ip	2
Key phone	69
Key:	
configuring	89
deleting	93

L

Labels	3, 110
LAN	106, 107
LED	25
Line key	69
Line:	
Answering a call on a Line key	69
Park call on Line key	70
Phoning over a Line key	70
Switching active lines	71
Listening in and recording	9
Local IP settings	82
Lock	49
Log in	105, 107
Loudspeaker key	3

M

Mains power (Safety information)	6
Maintenance (Safety information)	6
Making a call:	
in hands-free mode	17
in open listening mode	16
on a third-party phone	58
with headset	18
with supplementary features	26
Malfunctions	112
Managing personal greeting	86
MCID	61
Menu-guided navigation	24
Metal objects (Safety information)	6
Microphone key	3
Mode	58
Mounting	101
Moving the Cursor	23
Muting	17
Muting the microphone	17

N

Navigation key	2
Number key	90

O		
One number user concept	8	
Open listening	16	
Open Source Software	113	
Operating elements:		
Astra 5370/5370ip	2	
Options	100	
Organizing absence	42	
P		
Parking a call partner	40	
Password	80	
Personal call routing	62	
Phone book entry:		
creating	84	
deleting	85	
editing	85	
Phone book key	3	
Picking up a call	57	
PoE	107	
Power-Over-Ethernet	107	
Presence	42	
Presence key	3, 42	
Private call with PIN	36	
Product information	6	
Protection settings	83	
Purpose and function	8	
Q		
Quickdial	27	
R		
Recording a call	40	
Redial	16, 31	
Redial key	3	
Reject	54	
Reject a call during the ringing phase	54	
Remote control	66	
Resetting activated features	25	
Ring alone	62	
Ring off	76	
Ringing melody	76	
Ringing speed	76	
Ringing volume	76	
S		
Safety information	6	
Selecting the language	79	
Set the ringing volume	75	
Setting the ringing properties	75	
Setting up	101	
Shift key Aastra M535	3	
Silent intrusion	63	
Software version	114	
Store a function under a key	91	
Store a phone number under a key	90	
Store a team partner under a key	92	
Storing the contact in the phone book	85	
Storing the phone number in the phone book	85	
Suppressing your call number	61	
T		
Team key	92	
Team:		
Announcement to team partner	68	
Calling a team partner	67	
Organisation within the team	67	
Substituting for a team partner	68	
Using the Team key	67	
Text message:		
reading	57	
sending	56	
Text mode	22	
Third-party phone	58	
To activate headset operation	78	
Tracking a malicious call	61	
Trademarks	10	
Transferring a call partner	39	
Troubleshooting	112	
U		
Unlocking	50	
Upper and lower case	23	
User information	7	
Using the display and operating elements	19	
Using the Foxkey	21	
Using the Navigation key	24	
V		
Voice mail	46	
Voice mail:		
configuring	86	
Voice message:		
listening	54	
Volume	75	
Volume/cursor keys	3	
W		
Wall mounting	103	



Declaration of conformity

Aastra Telecom Schweiz AG hereby declares that

- the Aastra 400 products conform to the basic requirements and other relevant stipulations of Directive 1999/5/EC.
- all our products are manufactured in conformity with RoHS and WEEE (2002/95/EC and 2002/96/EC).

The product-specific declarations of conformity can be found on the Aastra 400 DocFinder:

www.aastra.com/docfinder.

Exclusion of liability

Aastra® is a registered trademark of Aastra Technologies Limited. Technical modifications and product availability subject to change without notice.

Copyright © 2012 Aastra Technologies Limited

